

User Manual



PV Array Combiner Box

6、 Appendix

6.1、 Quality assurance

This product quality assurance period 1 year, otherwise stipulated in the contract period of the contract shall prevail.

6.2、 Evidence

Products in the quality assurance period require customers to buy the products show the invoice and date. At the same time the product of the trademark shall be clearly visible, or shall have the right to not be quality assurance.

The following situation, this company has the right to not to quality assurance:

- 1、 Man-made damage to the equipment
- 2、 Wrong installation and use
- 3、 When using the maximum limit parameters beyond equipment requirements;
- 4、 Abnormal natural environment damage caused;
- 5、 Beyond that in this manual are very bad environment operation;
- 6、 Beyond the relevant international standards specified in the installation and use of range.

6.3、 Contact us



Do you have any questions about our product welcome to contact us and we will gladly for you to answer!

Catalogue



1、 Identification and description.....	1
2、 Product introduction.....	2
3、 Main feature.....	3
4、 Technical data.....	4
5、 Installation and use.....	4
6、 Appendix.....	7

1、 Safety instructions

1.1、 In order to better use product, please read the following instructions symbol:

	<p>WARNING !</p> <p>This symbol identification for informal operation might be in the safety of users dangerous or may cause significant hardware damage.</p>
	<p>INDICATE !</p> <p>This symbol identification for good system required for the operation of the matters needing attention.</p>

1.2、 Installation before use, please read this manual.

	<p>WARNING !</p> <p>All the operation and line connection ask professional personage to operation.</p>
	<p>WARNING !</p> <p>Please pay attention to personal and equipment safety.</p>

5.3、 Fast connection

5.3.1、 In order to improve the connection of rapidity and convenience, use key to open the door of combiner box ,the photovoltaic array input wire connected to the corresponding terminal, pay attention to the photovoltaic array input line of the positive and negative polarity connection.

5.3.2、 The combiner is independent two sets of photovoltaic array input/output design, through reasonable photovoltaic array input connection, output power can be divided into two ways, to match the two way independent input controller is used.

5.3.3、 when users connection system, please make sure that all the lines and equipment is reliable.

5.4、 Over-current protection

When the pv module input current is too large, the fuse will break for protection; In addition, miniature circuit breaker also can prevent the system from current is too large, have over-current protection function.

	<p>WARNING !</p> <p>It is strictly prohibited to work in touch fuse, inspection or replacement is required before the fuse will dc circuit breaker off; Must be replaced with the original model of the same magnitude fuse.</p>
--	---

5.5、 Over-voltage protection

When the pv module input voltage is high, the miniature circuit breaker will automatically disconnect, have overvoltage protection function.

5.2、 Installation: box installation size

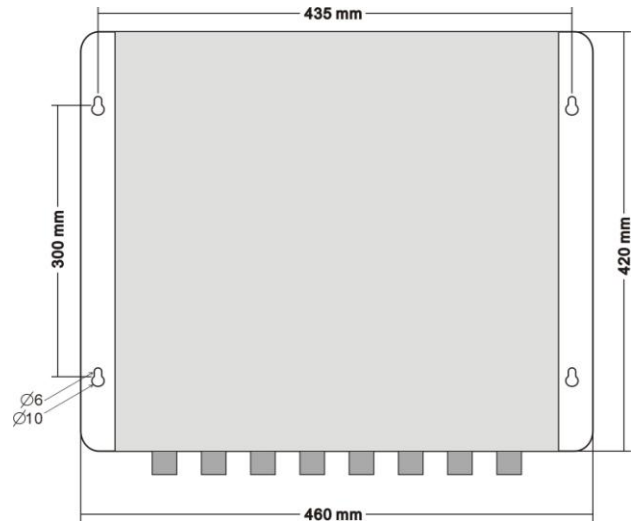

4-6 road input

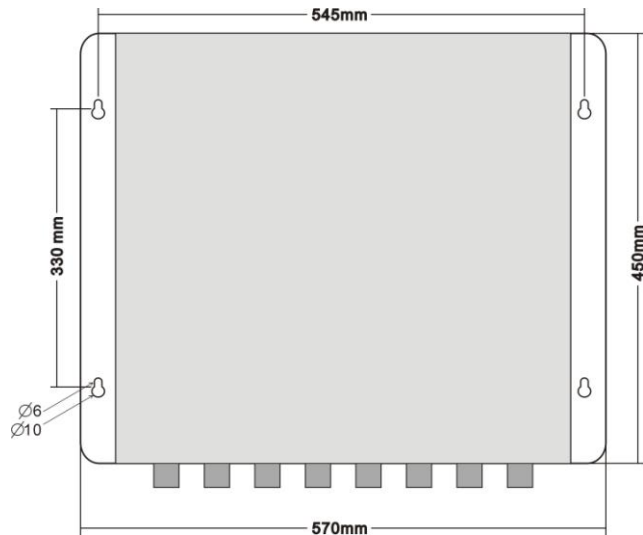

8-10 road input

Please arrange professionals and strictly in accordance with the above dimensions for operation.

	<p>WARNING !</p> <p>Please note that photovoltaic array input of positive and negative polarity and the total output of the positive and negative polarity.</p>
	<p>WARNING !</p> <p>Installation or connection pv modules, please note pv modules produce high voltage, avoid shock hazard.</p>
	<p>WARNING !</p> <p>Ensure that the connection of fastening, for the user to use improper or cable wiring the loss caused by unstable, our company does not undertake any responsibility</p>

2、 Product introduction

Photovoltaic power generation system, in order to reduce the photovoltaic module and inverter between the connecting cables, convenient maintenance, reduce the loss and improve the safety and reliability of the product, generally require in the photovoltaic module and inverter added between confluence device.

Photovoltaic junction box besides having the function of pv bus outside, and at the same time, should also have a current counter-attack, over current protection, over-voltage protection, lightning protection and a series of perfect protection function.

This company produces the photovoltaic junction box with the above various functional requirements, and photovoltaic (PV) grid, from network type inverter supporting the use can form a complete set of photovoltaic power generation system solutions.

Select photovoltaic junction box, the user can according to the back end inverter input voltage range, output power size, a certain number of specifications of the same pv module series, parallel composition pv module series coordinate access photovoltaic junction box (see Figure1) bus, and then after circuit breaker control and lightning protection device protection after output for level inverter use.

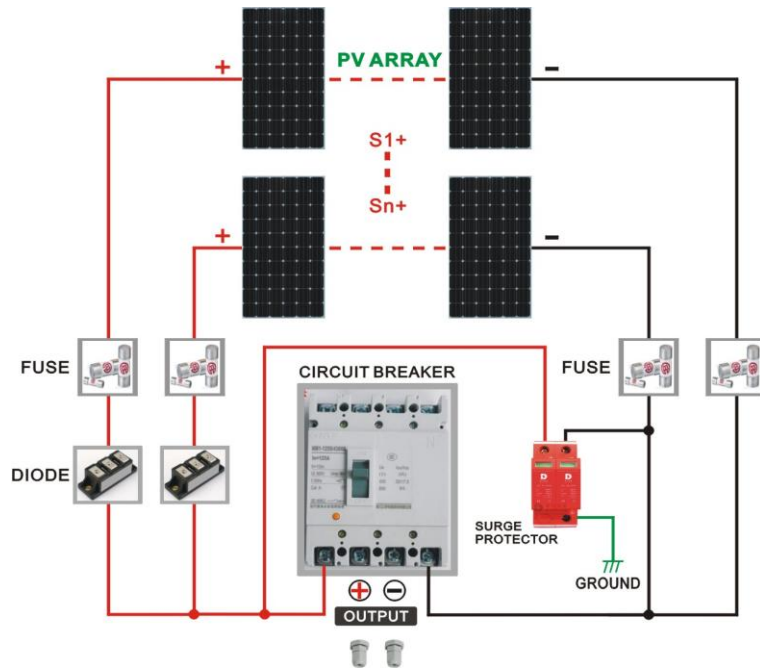

Figure 1 System connected graph

3、 Main features:

- Single way photovoltaic array output, maximum open circuit voltage 1000V.
- Multway photovoltaic array input, single way input array maximum current of 16A.
- Single way photovoltaic array to join the high-voltage fuse protection, counter-attack protection.
- Photovoltaic special high voltage lightning protection device protection.
- Photovoltaic special high voltage circuit breaker control output.
- Meet outdoor installation requirements, protection class IP65.

4、 Technical data

Model	HT4	HT6	HT8	HT10
PV array input numbers	4	6	8	10
Max single PV array current	16A			
Single PV array fuse	16A			
Single PV array wire size	4mm ²			
Output numbers	1			
Max output current	64A	96A	128A	160A
output wire size	10mm ²	16mm ²	20mm ²	25mm ²
Max output voltage	1000VDC			
DC output circuit breaker	yes			
protection	IP65			
Temperature range	-30℃ ~ +60℃			
Reference weight (N. W/G. W.)	7.6 Kg/13Kg		12.2 Kg/18.8 Kg	
Machine size (D * W * H)	445*458*150mm		484*568*163mm	
Packaging size (D * W * H)	510*500*252mm		630*550*252mm	
Cooling way	Natural cooling			
SPD protection	yes			
Ground wire size	≥6mm ²			

5、 Installation and use

5.1、 Device check

The customer received the goods please check the packing list, if any discrepancy please immediately contact with the company!

- 1、 PV array combiner box
- 2、 key;
- 3、 user manual;