

User Manual

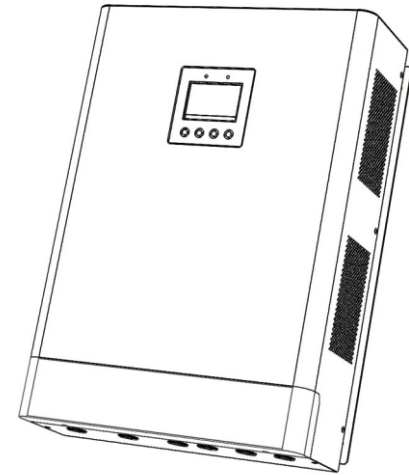

MPPT 240V-80/100
solar charging controller

10. Quality Assurance

If the machine break down during the warranty period, our company will repair or replace a new machine for free.

Evidence

During the warranty period, our company requires customers to show the invoice and date of purchase of the product. At the same time, the trademark on the product should be clearly visible, otherwise that will not be guaranteed.

Condition

- Disqualified machine after replacement should be disposed by our company
- Customer should reserve reasonable maintenance time for our company to repair faulty machine.

Liability Exemption

If meet the following situations, our company has the right not to guarantee the quality :

- Transport damage
- Operate in a very harsh environment beyond the instructions in this manual
- Machine failure or damage caused by repair, modification or disassembly by the service organization which is not our company
- Damage caused by abnormal natural environment
- Incorrect installation or modification
- The whole machine or parts exceed the warranty period

If the Fault/Abnormal is caused by the above conditions and customer requests repair service. After the judgment of our company's service organization, the paid repair service can be provided.



Notice

If the product size and parameters are changed, please refer to the latest information of our company and will not have prior notice.

Product Instruction

Thank you for choosing our new MPPT Solar Charging Controller .It is a product developed according to the latest technology which represents the latest development level of photovoltaic technology and has many excellent performance:

- Excellent heat dissipation design and Intelligent controlled cooling fan.
- Innovative maximum power point tracking technology, the conversion rate of up to 97%.
- Quick scan of the entire I-V curve , Efficient track the maximum power point.
- Three types of lead-acid battery, sealed, colloid, open type battery and lithium battery series charging procedures are optional.
- With the functions of over charge, over discharge, overload and short circuit automatic protection.
- With RS485 communication interface, It can communicate with multiple and the upper computers, which is convenient to check the operating parameters of the controller.

MPPT technology characteristics

MPPT controller uses the maximum power point tracking technology to extract the maximum power from the solar array to charge the battery.

Maximum power point tracking mode is completely automatic and does not require user adjustment .

When the maximum power point of the array varies with environmental conditions, the controller automatically tracks the maximum power point of the array to ensure that the maximum energy of the day can be obtained from the solar array .

• Improve The Current

In most cases, maximum power point tracking technology will "increase" the charging current of solar power generation systems .

If a system may have 10 amps of current flowing from the solar array to the MPPT controller, then 12 amps of current flowing from the MPPT controller to the battery .

If the maximum power point voltage of the solar array V_{mp} is higher than the battery voltage, the greater the current enhancement .

Current enhancement is very important in the system, because the maximum power point voltage V_{mp} of the solar panel in the solar power generation system is usually higher than the voltage of the battery.

Catalogue

1. Attentions	1
2. Safety Instructions	1
3. Open and Check the equipment	3
4. Installation and instruction	3
4.1 Selection of installation location	3
4.1.1 Operation Environment	4
4.1.2 Safety Distance	4
5. MPPT controller connection	4
5.1 Solar charging system composition	5
5.2 System connection diagram	5
5.2.1 Wiring steps	5
5.2.2 Battery Connection Instruction	5
5.2.3 Photovoltaic module connection	6
5.2.4 Temperature sensor and MPPT controller connected with PC	7
5.3 Power on trial operation	7
6. Operation instructions	8
6.1 Description of panel components	8
6.2 Indicator light status	8
6.3 LCD display instruction	9
6.3.1 Main interface description	9
6.3.2 View main interface	9
6.3.3 Main Menu	10
6.4 Parameter setting	12
6.4.1 Operation Parameter Setting	12
6.4.1.1 Battery Type Setting	12
6.4.1.2 Rated Battery Voltage Setting	13
6.4.1.3 Charging Voltage Setting	13
6.4.1.4 Charging Current Setting	14
6.4.1.5 Discharge Limitation Setting	14
6.4.1.6 Restore Factory Defaults	15
6.4.1.7 Password	15
6.4.2 Time and Date setting	15

9. Maintenance and Cleaning

9.1 Replace The Fuse

If the fuse is blown due to excessive temperature or other faults, you need to replace the fuse correctly. Remove the broken fuse from the interface, install a new fuse, and then check if the connection is correct, then install the device. (The fuse is near the wiring box.)

9.2 Cleaning The Vents & Heat Sink

Clean the fan vents and internal heat sinks regularly, and wipe them with a dry or slightly damp cloth. Note: Do not use washing liquid or corrosive solvent to clean. Do not allow liquid to flow into the machine and ensure that the ventilation holes of machine are not blocked.

8. Resolve Malfunction

When an abnormality occurs in the controller, please check the following table before contacting the customer service representative.

Fault/Abnormal	Solutions
MPPT controller is powered on for the first time, the fault reminder:battery voltage is beyond the normal recognition range.	1.Check if the battery voltage is within the system voltage identification range. (Find system voltage identification range column in technical parameters form) 2.Set the rated battery voltage level manually. (Find the rated battery voltage setting in the operating parameter settings form)
Fault Reminder Over Temperature Protection	1.Check if the cooling fan is damaged and if the vents are blocked by debris. The MPPT controller should be installed in a ventilated environment. 2.A reasonable PV module configuration can increase conversion efficiency and reduce temperature rise. (Find PV module configuration in technical parameters
Fault Reminder:Battery Over Discharge Protection	Waiting for the battery to run out of energy
Fault Reminder : No external temperature sensor detected	1.Check if connect the external temperature sensor. 2.Check if the sensor is in poor contact.
Charging indicator is off and no charging current, charging power display	1.Whether the PV module voltage is within the operating voltage range of the MPPT controller. 2.Check if the charging voltage parameter in the system information display is correct. 3.Restart the MPPT controller after correcting the charging voltage parameters or restoring the factory settings. 4.Check if the fuse is blown and the breaker if disconnected.
The charging indicator lights up shortly and goes out, sometimes there is no charging current	This situation usually occurs when there is insufficient light in cloudy day or evening, which is a normal phenomenon
No power curve and current curve display	Check if the time and date displayed of the MPPT controller are correct (Find in time and date settings)

If the problem persists after following the solutions in the above form, please contact the maintenance personnel.

Please provide the following information:

Equipment Information: Model number, Order number, Serial number (Labeled on the back panel);

Detailed Description of the problem (Such as the system type, problem occasionally appear or often appear, indicators, display situation, etc.)

Catalogue

6.4.3 Brightness setting	16
6.4.4 Contrast ratio setting	16
6.4.5 Voice setting	16
6.4.6 Records query	17
6.4.7 Delete record	17
6.4.8 DC output Settings	18
6.4.9 Communication Setting	19
6.4.10 Language setting	19
7. Technical Parameters	20、21、22
8. Troubleshoot	23
9. Maintenance and cleaning	24
10. Quality Assurance	25

1. Attentions

This manual introduces the operation of MPPT solar charging controller.

1.1 Availability

This manual is applicable to MP series MPPT solar charging controllers of our Factory .



1.2 Target Consumers

This manual is applicable to installers and operators .

1.3 Before installing and operating the controller, please read it first and be sure to keep it for reference .



1.4 Symbol Description

The following is a description of the type of Symbol that appears in this manual :

	Warning ! Warning indicates that if not avoided, it may cause machine failure or accident .
	Warning ! Warning indicates that if not avoided, it may cause machine failure or accident .
	Attention! In order to operate the equipment effectively, please read the instructions carefully .

2. Safety Instructions

2.1 Safety Precautions

	Warning ! <ul style="list-style-type: none"> • This controller input voltage range is large. please operate carefully, otherwise it will cause personal injury . • All work on the charging controller must be done by technicians • .
	Warning ! High temperature housing parts <ul style="list-style-type: none"> • Please install in a good heat dissipation and ventilation environment.
	Warning ! Radiation can damage health. <ul style="list-style-type: none"> • Don't stay near solar charging controllers less than 20 centimeters away for long .

Technical Parameters

Model:MP-80/100	80A	100A
Attributes		
Size(mm)	544*382*163	
Net Weight(kg)	21	21.3
Mechanical Protection Type	IP21	
Environmental Requirements		
Humidity	0~90%RH (No condensation)	
Altitude	0~3000m	
Ambient Temperature	-20°C~+40°C	
Storage Temperature	-40°C~+70°C	
Atmospheric Pressure	70~106kPa	
PV Module Configuration		
System Battery Voltage	PV module load voltage (Recommended Value)	
192V System	230V~420V (30V module*11 string, 36V module*10 string)	
240V System	280V~420V (30V module*11 string, 36V module*10 string)	



Technical Parameters

Model:MP-80/100		80A	100A
Floating Charge Voltage (Lead Acid Battery)	96V System	110.40V(Can be customized)	
	192V System	220.80V(Can be customized)	
	240V System	276.00V(Can be customized)	
Average charging Voltage (Lead Acid Battery)	96V System	116.00V(Can be customized)	
	192V System	232.00V(Can be customized)	
	240V System	290.00V(Can be customized)	
Rated Current	96/192/240V	80A	100A
Current Limiting Protection	96/192/240V	82A	102A
Temperature Coefficient	96/192/240V	$\pm 0.02\%/^{\circ}\text{C}$	
Temperature Compensation	96/192/240V	14.2V-(Maximum Temperature -25C)*0.3	
Output Regulation Accuracy	$\leq \pm 1.5\%$		
LCD Display	Details in LCD Display Instruction		
LED Display	Charging Indication, DC Output Switch Status Indication		
PC Host Computer	Rs485(Optional)		
Protection			
Input Low Voltage Protection	Reference Input Characteristics		
Input High Voltage Protection	Reference Input Characteristics		
Input Polarity Reverse Connection Protection	Available		
Output Polarity Reverse Connection Protection	Available		
Short Circuit Protection	After 5 trial starts will enter the protection state, Restart Recovery		
Temperature Protection	85 $^{\circ}\text{C}$		
Temperature Rise Protection	Reduce Power Output When Exceed 80 $^{\circ}\text{C}$		
Other Parameters			
Noise	$\leq 50\text{dB}$		
Heat Dissipation Method	Forced air cooling, fan speed is adjusted by temperature, when the internal temperature is low, the fan runs slowly or stops; when the controller stops working, the fan will stop running		
Element	Imported Materials, in line with EU standards, all temperature selection of electrolytic capacitors rated temperature is not less than 105 $^{\circ}\text{C}$		
Smell	Do not release peculiar smell and harmful health smell		
Environmental Requirements	Conform 2002/95/EC; No Cadmium,Hydride and Fluoride		

2. Safety Instructions



2.2 Marks Instruction

This section shows instructions for the flags displayed on all device labels.

Marks	Instruction
	Danger of electric shock . The energy stored in the capacitor will remain after disconnection and do not touch the internal components in 5 minutes .
	Do not attempt to remove the cover without self-repairing parts inside the machine. Only professionals can operate and maintain the equipment. Use insulated tools when operating to reduce the risk of damage .
	Beware of a hot case The solar charging controller gets hot during operation.Avoid contact during operation .

2.3 Safety Instructions

- When using the device, please remember the following information to avoid fire, lightning strike or other personal injury .

	Ensure that the maximum input DC voltage is \leq specified Max. Voltage, too high voltage may cause permanence Long-term damage to the solar controller, the above situation will not be included in the warranty period . This chapter contains important safety and operational instructions.Read and retain this manual for future reference .
	Technicians must follow steps to maintain or clean solar controllers or to connect them to electrical circuits .

- Before using the solar charging controller, all instructions and warning marks on the solar charging controller and corresponding chapters of this manual should be read .

- Please use the parts recommended or sold by our company .
- In order to avoid the danger of fire and electric shock, ensure the existing lines have good conditions and suitable wire dimensions.Do not operate when the solar controller is damaged and wiring is not qualified .
- Keep away from inflammable and explosive materials to avoid fire.
- Install away from damp or corrosive materials .
- To avoid short circuit, technicians must operate the equipment with insulation tools.

3. Open and check the equipment

3.1 Accessories Including

Specifications	Number	Note
Controller	1	
Communication line/ CD	1	Options
Temperature Sensor	1	
User Manual	1	

(If you find any missing parts, please contact the dealer .)

3.2 Check whether there is any damage during transportation.

After receiving the equipment, do not be in a hurry to sign for acceptance. Please open the seal first to check whether the equipment has obvious falls such as deformation or shell cracks. If there is similar damage, please refuse to sign for acceptance and contact the dealer.



3.3 Determine charging controller

The label of this charging controller is on the side of the case. If you find that it is inconsistent with what you bought, please contact the dealer .

4. Installation and instruction

The installation must be done by a professional technician

4.1 Selection of installation location

	<p>Danger : The controller cabinet gets hot during operation .</p> <ul style="list-style-type: none"> • Do not install on flammable building materials • Do not install near highly flammable materials • Do not install in areas with potential explosion hazards • Do not install the charging controller in direct sunlight to avoid the loss caused by power overheating .
	<p>Caution ! Due to built-in thermal storage module components</p> <ul style="list-style-type: none"> • Please do not open the enclosure while the controller is working. Do not touch it by hand .

7. Technical Parameters

Model:MP-80/100	80A		100A		
Charging Mode	MPPT Automatic Maximum Power Point Tracking				
Charging Method	Three stages : Constant Current (MPPT), Balanced Charging, Floating Charge				
System Type	96/192/240(V)	Automatic Identification/Manual Setting			
System Identification Voltage Range	96V System	DC72V-DC120V			
	192V System	DC144V-DC240V			
	240V System	////////////////////			
Soft Start Time	96/192/240(V)	≤10s			
Dynamic Response Recovery Time	96/192/240(V)	≤500us			
Static Power	96/192/240(V)	≤6W			
Machine Efficiency	96/192/240(V)	≥96.5%			
PV Module Utilization	96/192/240(V)	≤99.97%			
MPPT Operating Voltage Range	96V System	DC130V-DC420V			
	192V System	DC260V-DC420V			
	240V System	DC290V-DC420V			
Input Low Voltage Protection Point	96V System	DC120V			
	192V System	DC240V			
	240V System	DC270V			
Input Low Voltage Recovery Point	96V System	DC130V			
	192V System	DC260V			
	240V System	DC290V			
Limit Input Voltage	96/192/240(V)	430V			
Overvoltage Protection	96/192/240(V)	425V			
Overvoltage Recovery	96/192/240(V)	420V			
Maximum Solar Panel Input Power	2 Input Solar	Solar1	Solar2	Solar1	Solar2
	96V System	4000W	4000W	5000W	5000W
	192V System	8000W	8000W	10000W	10000W
240V System	10000W	10000W	12500W	12500W	
Optional Battery Type (Default is lead-acid maintenance-free battery)	96/192/240(V)	Lead-acid maintenance-free Battery, Gel Battery, Liquid Battery, Lithium Battery (Can also be customized for other types of battery)			

6. Operation instructions

6.4.9 Communication Setting(Communication setting invalid)

Under the default main interface, press MENU key to enter the main MENU, press DOWN key to select communication Settings, press ENTER key to enter communication Settings, press UP key to select baud rate setting or local address setting, press DOWN key to set baud rate and the machine address value, press ENTER key to confirm, after hearing continuous prompts, press MENU key to return to the upper MENU and main interface

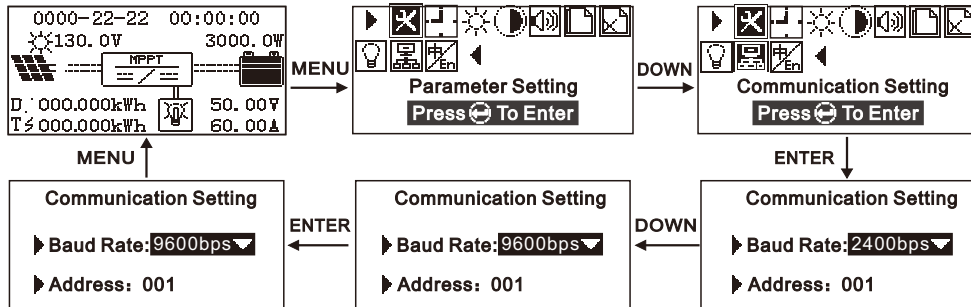

6.4.10 Language setting

In the default main interface, press key MENU enter into main menu, then press key DOWN into language setting, then press key ENTER into language setting, press key DOWN to chose language, and press again key ENTER to confirm, press key MENU back to main menu when sound continuous prompts

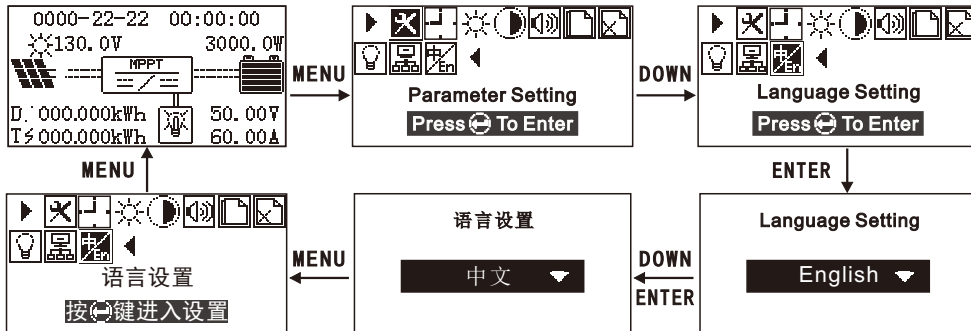

4. Installation and instruction

4.1.1 Installing Environmental Conditions

- Mounted on a solid surface
- The installation location must be accessible at all times
- Install a location that can be removed at any time
- The environment temperature should be $-20^{\circ}\text{C} \sim 50^{\circ}\text{C}$ to ensure the optimal working environment .
- Do not install the charging controller in direct sunlight to avoid power loss due to overheating.

4.1.2 Safety Distance

Observe the following safety clearances to ensure that other equipment or objects are not in this range to ensure adequate cooling space .

Instructions	Safety Distance
Side	20CM
Top	30CM
Bottom	30CM

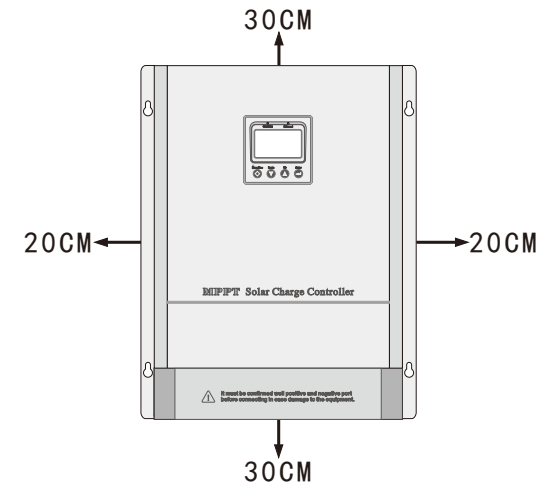

5. MPPT controller connection

	<p>Danger ! If the high voltage input, the operation is not correct, solar charging controller may lead to life risk .</p> <ul style="list-style-type: none"> • Disconnecting solar panel arrays should use circuit breakers and avoid accidental activation of power • Disconnect the circuit breaker and make sure it cannot be reconnected, make sure there is no voltage in the system .
	<p>Caution ! Overvoltage damages the system</p> <ul style="list-style-type: none"> • Thunderstorms and lightning can increase the risk of damage to external overvoltage protection areas .

5. MPPT controller connection

5.1 Solar charging system composition

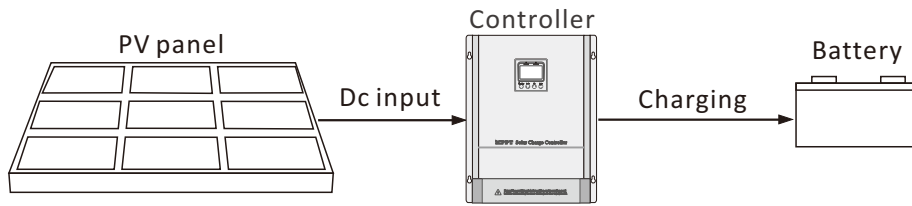

5.2 System connection diagram

5.2.1 Wiring steps

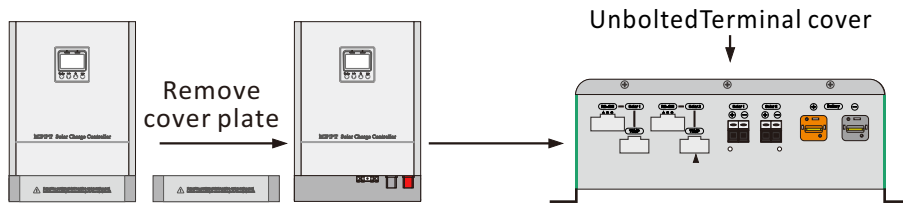

5.2.2 Battery Connection Instruction

Caution : Battery positive and negative terminal and connected to the positive and negative pole of the wire short circuit will cause fire or explosion risk, please be careful to operate.

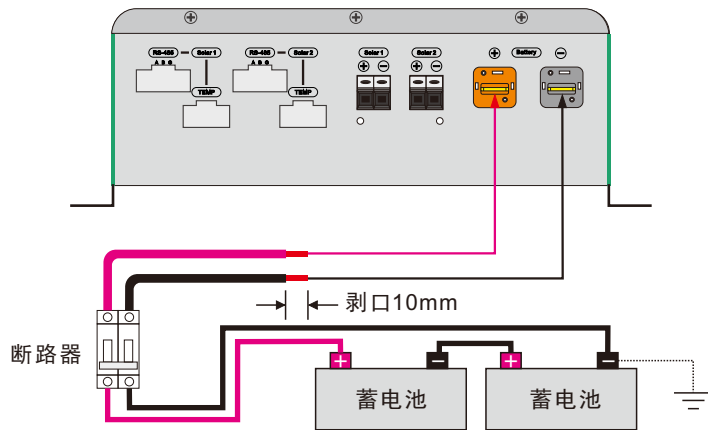

Notice : The connection of the battery pack must be made when the circuit breaker is disconnected .

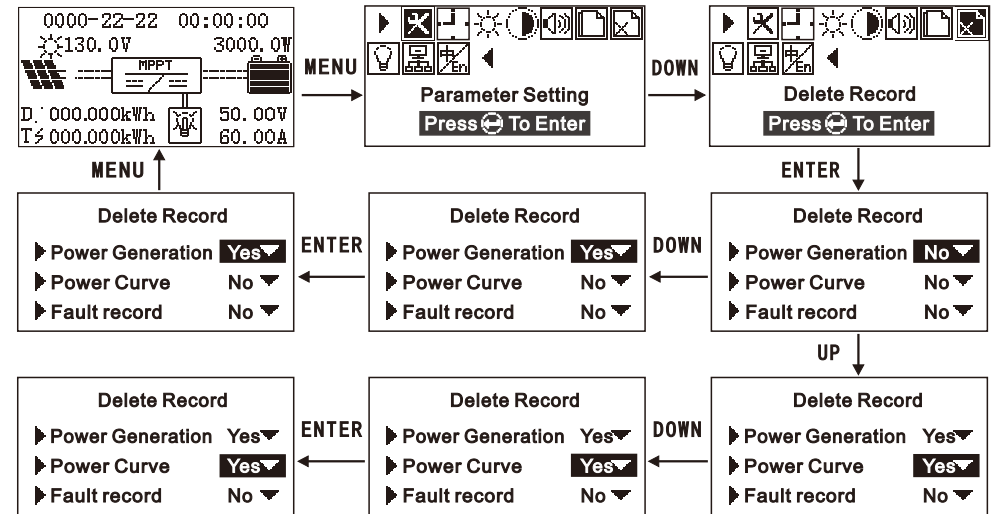

6.4.8 DC output Settings(DC output disabled)

In the default main interface, press the MENU key to enter the main MENU Press DOWN key to select DC output setting, press ENTER key to enter DC output setting, press DOWN key to select close, automatic, time control and light control. When selecting close or automatic, press ENTER to confirm. When selecting time control, it needs to Open time period open and close DC output . Press DOWN key to select time control and then press UP key to move the cursor, press DOWN key to enter the time value. Press ENTER to confirm, After hearing the continuous prompts, press MENU key to return to the upper layer and the main interface .

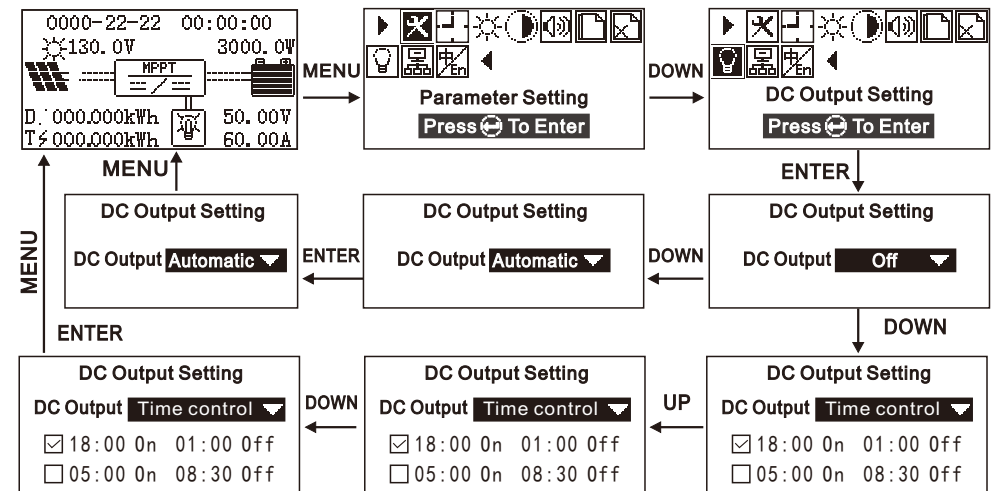

6. Operation instructions

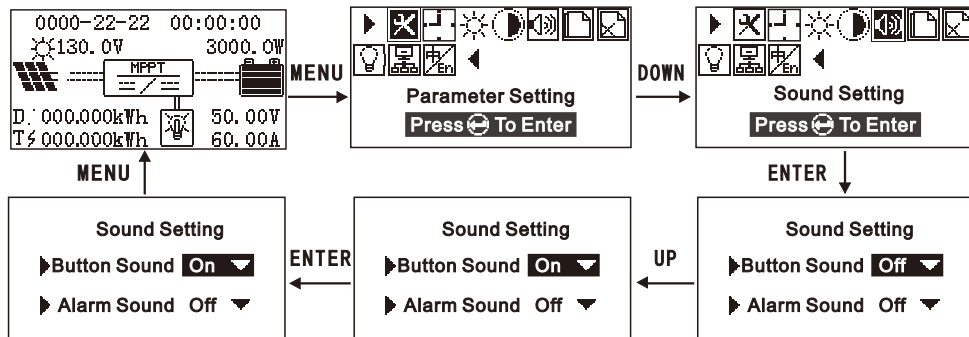

6.4.6 Records query

In the default main interface, press key MENU enter into main menu, then press key DOWN into records query, press key DOWN or UP to chose curve record query or fault records query , user can check 10 records via key DOWN or UP after entry, then press key MENU back to main menu when sound continuous prompts

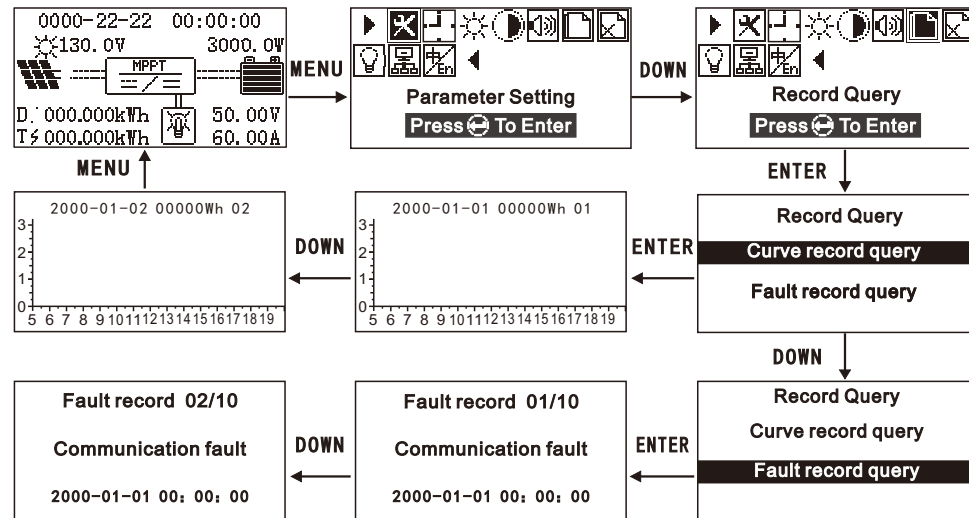

6.4.7 Delete record

In the default main interface, press key MENU enter into main menu, then press key DOWN to delete record, press key ENTER to delete , and press again key UP to move pin , then press again key DOWN to confirm and press key ENTER again to set well, press key MENU back to main menu when sound continuous prompts

5.2.3 Photovoltaic module connection



Warning : Shock hazard ! Photovoltaic modules may generate high voltages, and be careful to avoid electric shocks when wiring.

The controller can be used for off-grid solar modules of 96V and 192V, or grid-connected modules with open circuit voltage not exceeding the specified maximum input voltage. The solar module voltage in the system shall not be lower than the system voltage.

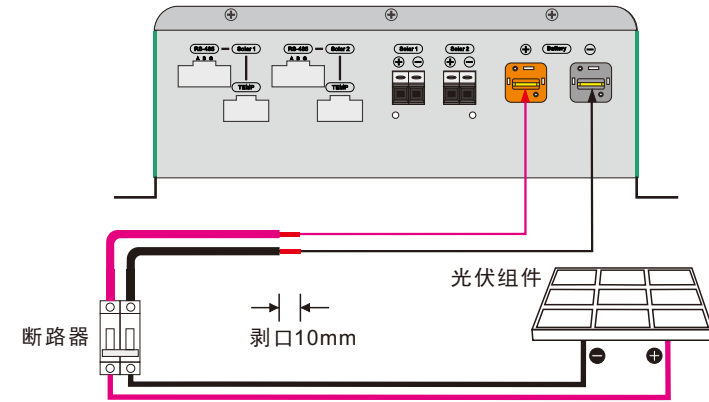

Notice : photovoltaic modules must be connected when the circuit breaker is disconnected .

5. MPPT controller connection

Specification for cables and microcircuit breakers

Model	80A	100A	120A
Cable copper	16mm ²	20mm ²	25mm ²
Breaker	150A	150A	200A

5.2.4 Temperature sensor and MPPT controller connected with PC

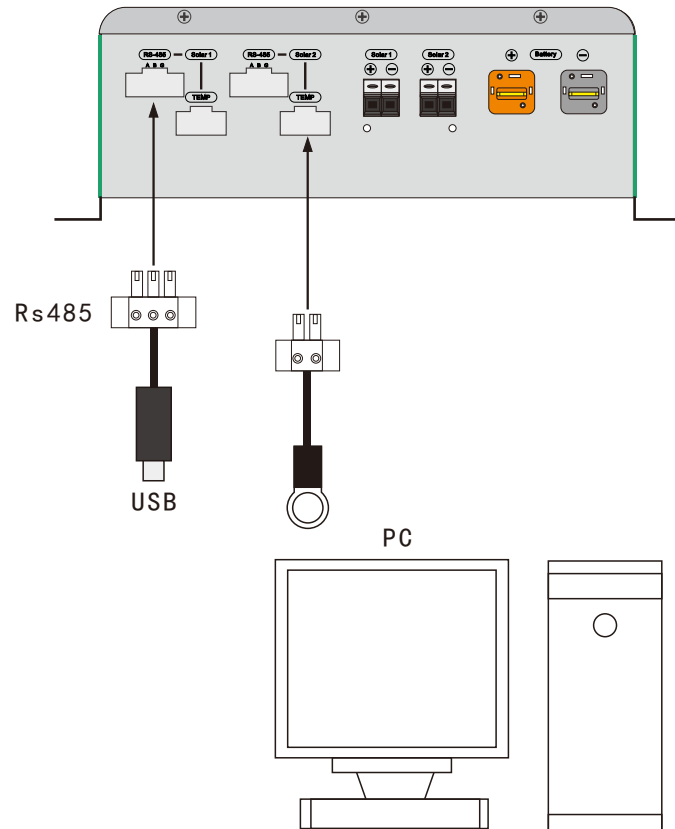

Rs485 communication line is optional

If necessary, install the upper computer software (purchased separately).

Accessories with detailed instructions for use and installation

5.3 Power on trial operation

 Notice : Please check that all the positive and negative terminals of the DC connection wire should be fully connected before power on trial operation

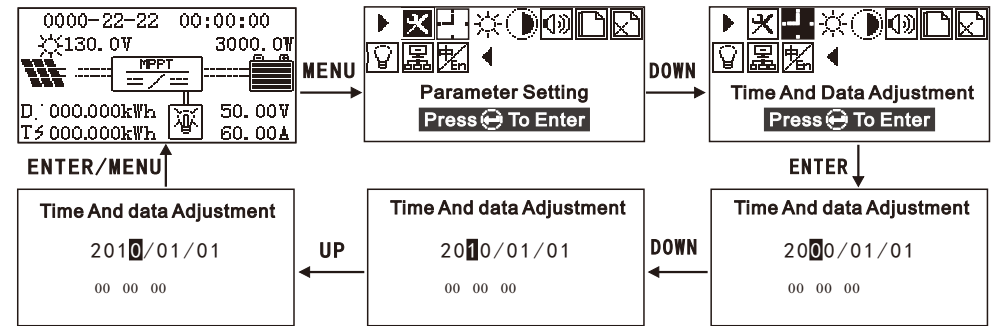

6.4.3 Brightness setting

In the default main interface, press MENU key to enter the main MENU, press DOWN key to select the brightness setting and then press ENTER to enter the brightness setting, Press DOWN to reduce the brightness, press UP to increase the brightness, and press ENTER to confirm, press the MENU key to return to the previous menu and main interface after hearing the continuous prompt sound

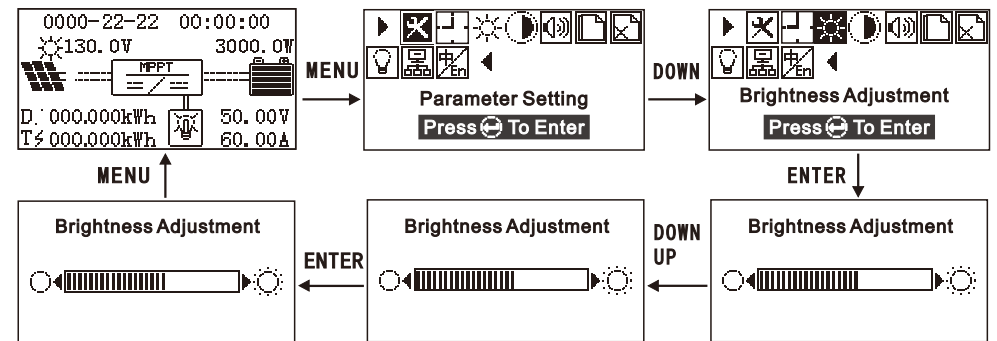

6.4.4 Contrast ratio setting

Contrast ratio setting is the same with brightness setting

6.4.5 Sound setting

In the default main interface, press key MENU enter into main menu, then press key DOWN into sound setting, press key ENTER to sound setting, and press again key UP to move pin to chose alarm on/off, then press again key ENTER to confirm and press key MENU back to main menu when sound continuous prompts

6. Operation instructions

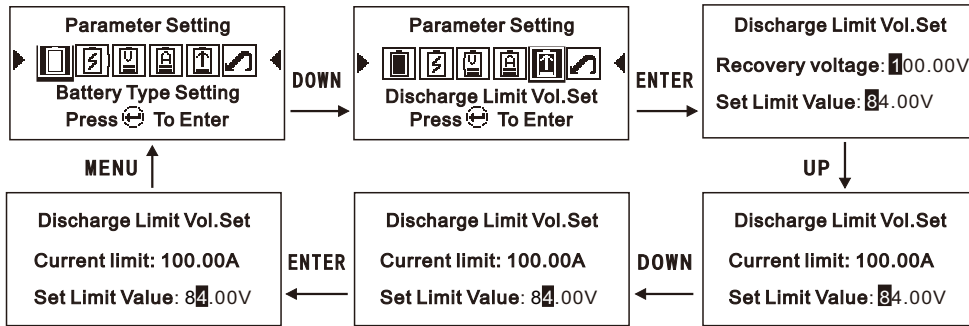

6.4.1.6 Restore Factory Defaults (Parameter setting disabled)

In the operation parameter interface, press DOWN key to select the factory reset setting and press ENTER key to enter the factory reset setting. Press DOWN key to select whether to restore the factory settings, press ENTER key to confirm the save, press the MENU key to return to the upper interface after hearing the continuous prompt sound.

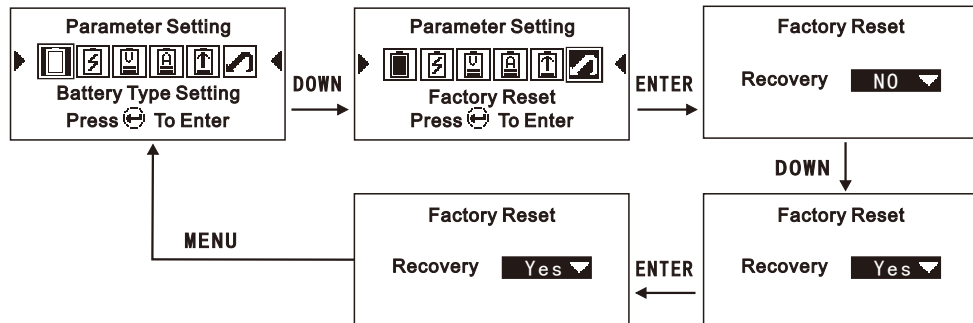

i When the operation parameter setting error causes the MPPT controller fail to operate normally, you can reset the operating parameters.

6.4.1.7 Password

Press DOWN button 3 times and then press UP button 3,*** press ENTER button to enter operating parameter setting**

6.4.2 Time and Date setting

In the default main interface, press key MENU enter into main menu, then press key DOWN into time setting, press key ENTER to set, and press again key UP to move pin and update value via key DOWN, press key ENTER to confirm after updating the value and back to main menu when sound continuous prompts

Follow these steps to test run:

1. Please Check whether the positive and negative poles of the connection line must be completely connected correctly, and measure whether the open circuit voltage of the photovoltaic module is within the working range of the controller.
2. Turn on the circuit breaker connecting the controller to the battery first.
3. Turn on the circuit breaker that connects the controller to the solar panel.
4. And then the controller goes into self-checking mode; The system condition is correct, the controller automatically enters the working mode; If the system conditions are not correct, the controller will be prompted for failure. Refer to the section for troubleshooting.
5. Battery type: the controller factory default lead-acid maintenance-free battery, refer to battery type Settings.

6. Operation instructions

6.1 Description of panel components

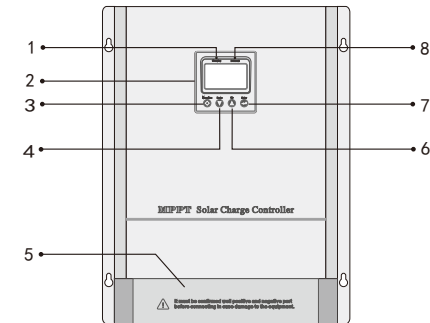

Number	Description	Number	Description
1	Charging indicator light	5	Junction box cover plate
2	LCD Display	6	Upturn button
3	Function menu button	7	Confirm button
4	Scroll down	8	Dc output indicator light

6.2 Indicator light status

Indicator light	State	Statement
Charging indicator	Quick Flash	Maximum power tracking mode charge
	Slow flash	Floating charging mode
	OFF	Stop charging
Dc output indicator	ON	Normal Output
	Flash	Battery undervoltage prompt
	OFF	Close the output

6. Operation instructions

6.3 LCD display instruction

6.3.1 Main interface description

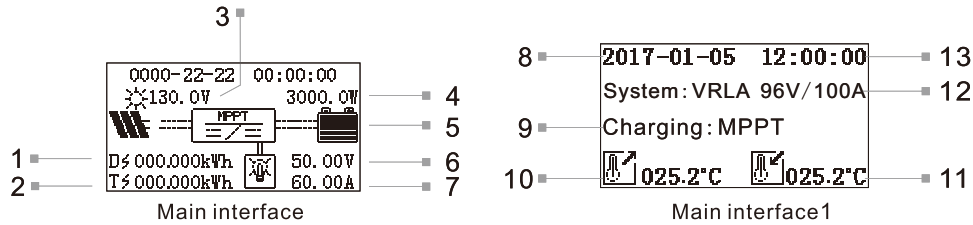

No	Status	No	Status
1	Daily power generation(charging volume)	8	Date
2	Total power generation(charging volume)	9	Charging state: maximum power tracking, floating charge, stop charging
3	PV module voltage	10	External temperature
4	Charging power	11	Internal temperature
5	Battery capacity indication	12	Battery Type / System Voltage Current Level
6	Battery voltage	13	Real time
7	Charging current		

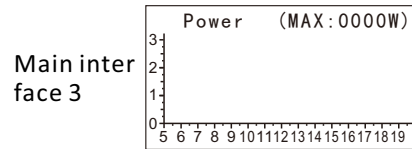
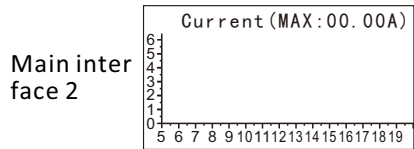

Number	Current (MAX: 00.00A)	Number	Power (MAX: 0000W)
X	Time (5: 00-20: 00)	X	Time (5: 00-20: 00)
Y	Current (proportion: 1: 10)	Y	Power (proportion: 1: 1000)
MAX:00.00A (Record the highest charging current value of the day)		MAX:0000W(Record the maximum charging power value of the day)	

6.3.2 View main interface

In the default home screen, press DOWN or UP to Check .

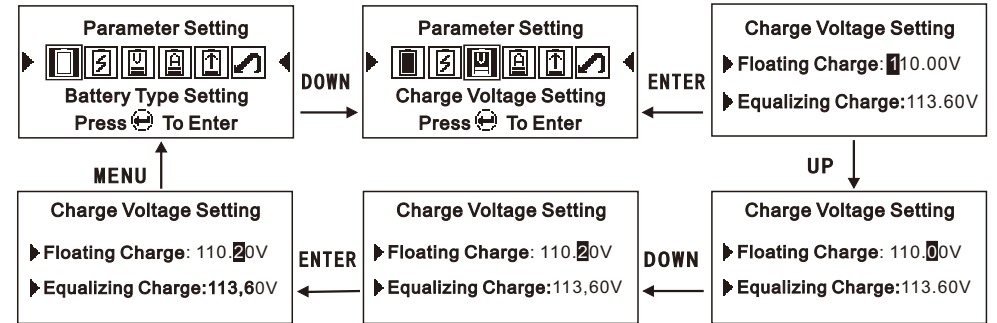
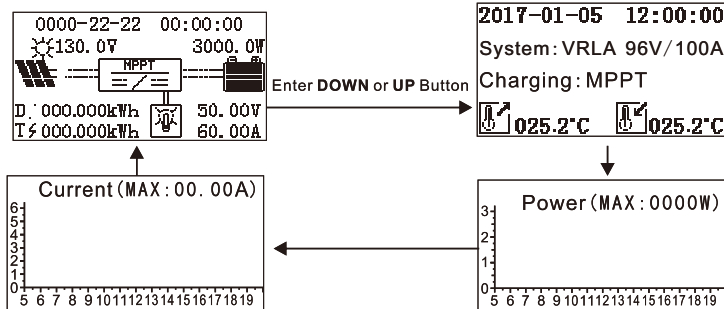

6.4.1.4 Charging Current Setting(Parameter setting disabled)

Under the interface of operating parameters, press DOWN key to select charging current setting, then press ENTER key to enter charging current setting, press UP key to move cursor, press DOWN key to enter value, press ENTER key to confirm and save. After hearing continuous prompts, press MENU key to return to the upper interface .

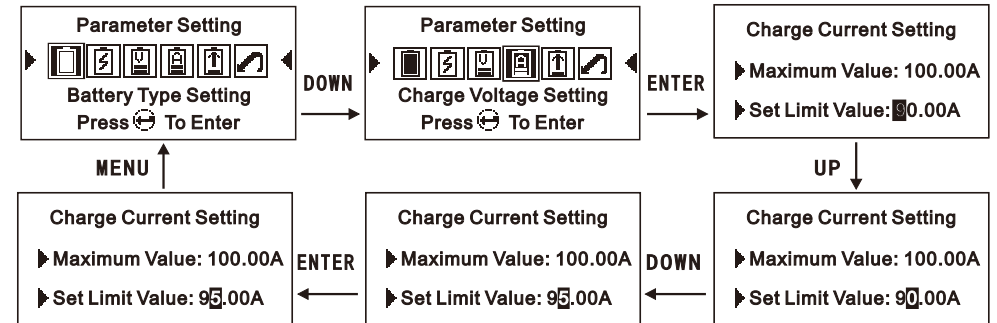

i The value of Charging current setting cannot be greater than the current maximum .

6.4.1.5 Discharge Limit Setting(Parameter setting disabled)

i The discharge limit setting refers to setting the shutdown voltage and recovery voltage setting of the DC output.

In the Operating parameter interface, press the DOWN key to select the discharge limit setting and press the ENTER key to enter the discharge limit setting. Press the UP key to move the cursor, press the DOWN key to enter the value, press the ENTER key to confirm the save, press the MENU after the continuous prompt will return to the upper interface.

6. Operation instructions

6.4.1.2 Rated Battery Voltage Setting(Parameter setting disabled)

Under the interface of operating parameters, press DOWN key to select rated voltage setting, then press ENTER key to enter rated voltage setting, press DOWN key to select rated voltage level (automatic identification 96V, 192V...) press ENTER key to confirm. After hearing the continuous prompts, press MENU key to return to the upper level.

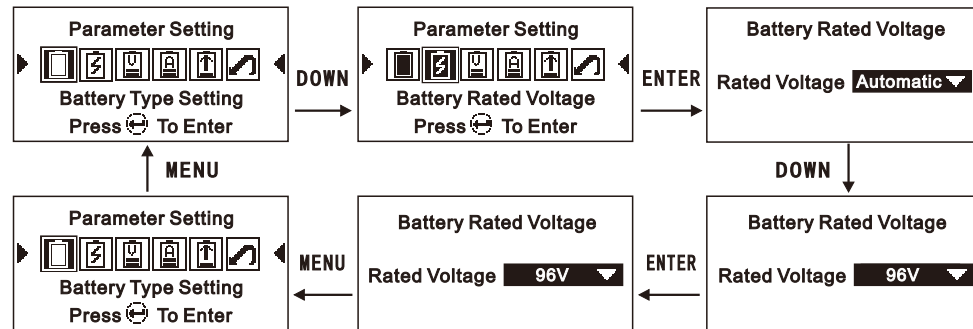

i Factory default for automatic identification of rated voltage level. Automatic identification of rated voltage only identifies lead-acid battery series, lithium battery series is not included in the automatic identification range. When automatic identification of voltage level, charging voltage and discharge lower limit voltage are not allowed. Setting the charging voltage and discharge lower limit voltage must be manually set the voltage level to allow setting.

6.4.1.3 Charging Voltage Setting(Parameter setting disabled)

Setting charging voltage steps:

1. Choose the battery type you use (lead-acid battery series or lithium battery series)
2. Set the rated battery voltage grade (the grade is 96V,192V...) see rated battery voltage setting for details (factory default battery type is lead-acid mainting-free battery, and battery voltage level is automatically recognized by default)
3. Fully understand the charging parameters of the battery you are using, and you must follow the charging parameters recommended by the battery manufacturer. Lithium battery series only set floating charge (constant voltage) charging mode, Equalization charging mode is only used in lead-acid battery series .

6.3.3 Main Menu(Parameter setting disabled)

In the default main interface, press MENU key to enter the main MENU, and press DOWN or UP key to view the submenu

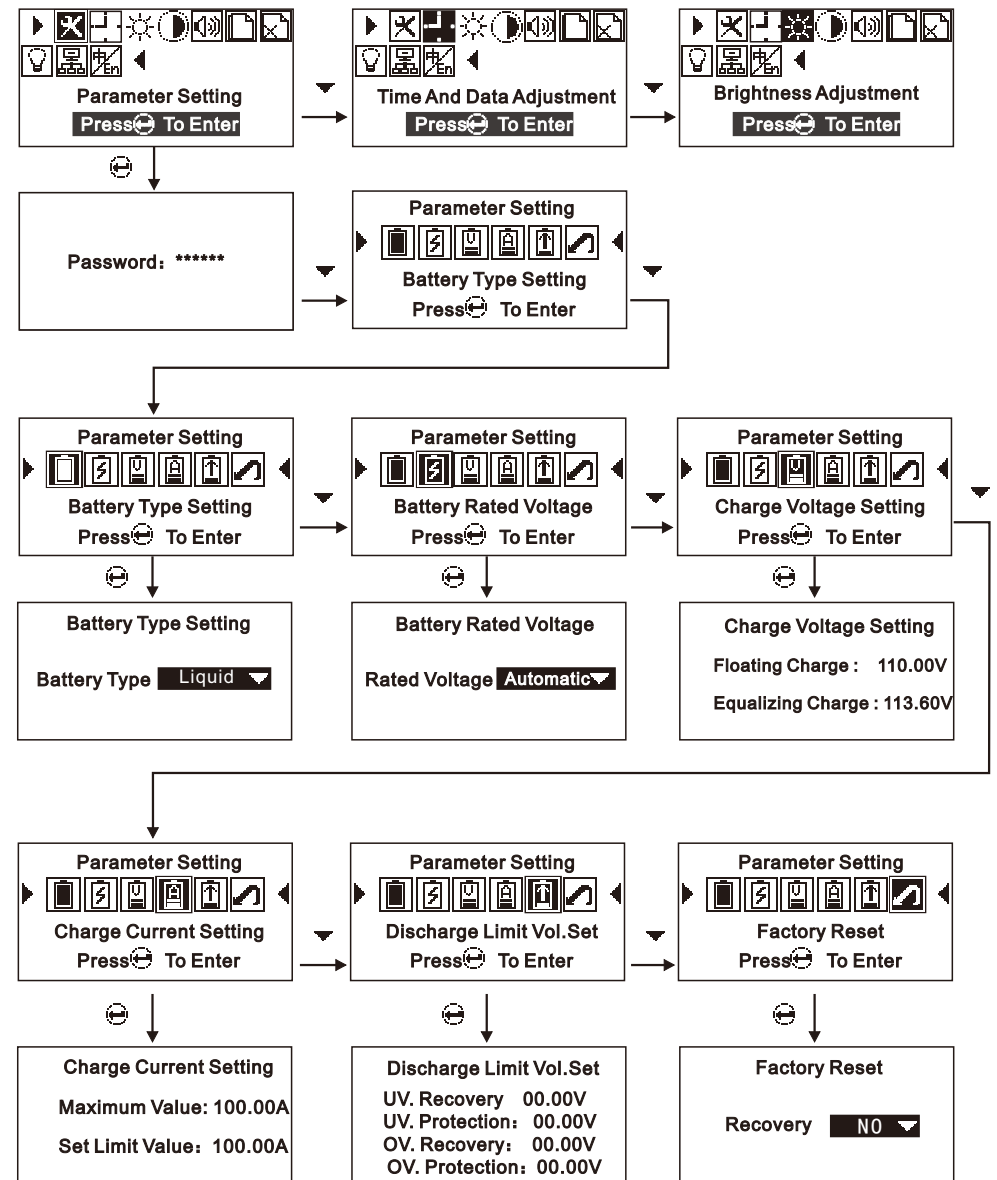

6. Operation instructions

Main menu

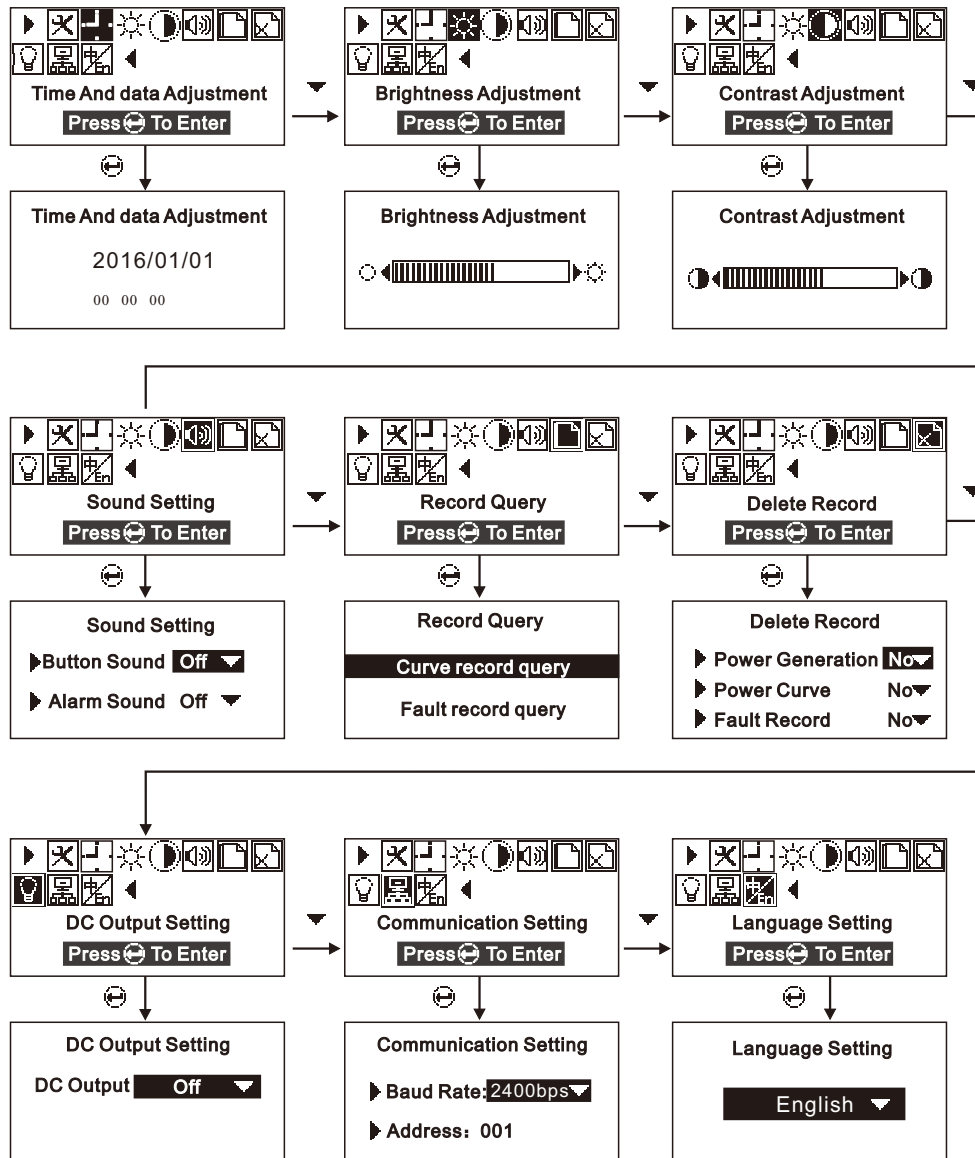

6.4 Parameter setting

6.4.1 Operation Parameter Setting

Note: the operation parameters must be set by professional technicians. Incorrect operation may result in the MPPT controller can not work properly or damage the battery .

Under the default main interface, press MENU key to enter the main MENU, press ENTER key to enter the password prompt interface, and press ENTER key to enter the setting of operating parameters after entering the password .

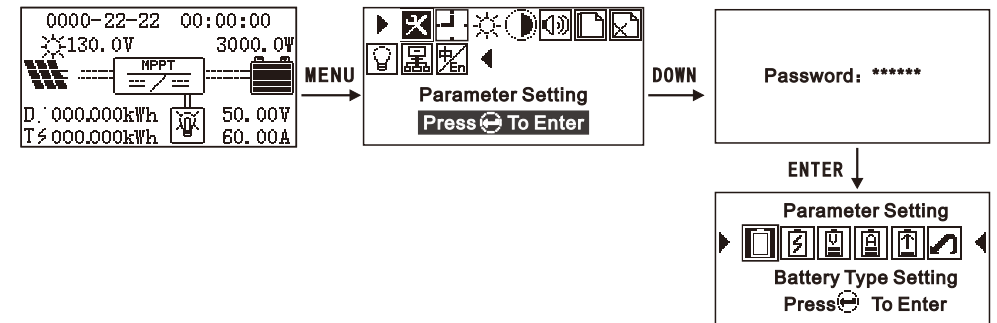

Note: Before setting operating parameters, the photovoltaic module must be disconnected from the circuit breaker connected to the MPPT controller. Then the battery type setting, rated voltage setting, charging voltage setting, charging current setting, discharge lower limit setting, 5 parameters should be completed in turn. Then check whether the parameters shown in the system information are consistent. Confirm the conformity before opening the photovoltaic module circuit breaker.

6.4.1.1 Battery Type Setting (Parameter setting disabled)

Under the interface of operating parameters, press ENTER key to enter battery type setting, press DOWN key to select battery type (lead-acid maintenance free, colloidal battery, liquid battery, lithium battery series), press ENTER key to confirm, and press MENU key to return to the upper layer after continuous prompts .

Factory default for lead-acid maintenance-free battery

