

由于印刷的关系，可能与实际产品的颜色有所差异，使用时请以实物颜色为准。  
Due to the printing process, the colors of the actual products may differ from the pictures for the actual effect please refer to the actual product when using

博威工具 0757-83128855

煊威磨具  
XUANWEI ABRASIVES  
博威工具  
BOWEI DIAMOND TOOLS



技术创新·以质取胜

Technology innovation,  
Win by quality

Foshan Bowei  
Diamond Tools Co.,Ltd.  
佛山市博威金刚石工具有限公司

地址：佛山禅城区南庄紫洞中路  
电话：0757-8256 9772 传真：0757-8256 9772  
邮箱：fsxuanwei@126.com QQ：373752491  
网址：fsxwmj168.1688.com

联系人：黄先生 手机：135 2898 8202





## 公司办公楼



**远景—**创造卓越的产品，服务社会！

**使命—**做世界一流的陶瓷抛光磨具供应商。

**核心竞争力—**以技术创新，管理创新，创一流产品。

Perspective—to create excellent products and serving society  
Mission – to be a world-class supplier of ceramic polishing tools.  
Core competencies – with technological innovation, management innovation, create a first-class products.

**发展依赖于科学的管理**

在煊威，我们实行开放式管理，培养和引进职业经理。我们强调团队精神，鼓励员工与公司共同成长。

Development depends on scientific management  
In Xuanwei, we implement open management, training and the introduction of professional managers. We emphasize team spirit and encourage employees to grow together with the company.

**创造力来自鼓励创新的企业精神**

建立富于创新精神的煊威，公司积极建立这样一种氛围，鼓励所有员工敢于打破个人和公司的限制，包括：管理、技术、产品、服务、结构等一切。

Creativity comes from the entrepreneurial spirit.  
That encourages innovation creating an innovative spirit of XuanWei.  
The company is actively creating an atmosphere in which all employees are encouraged to dare to break the limits of individuals and companies, including: management, technology, products, services, structure, and more.

## CORPORATION INTRODUCTION 公司简介

佛山市博威金刚石工具有限公司,已经成功地开发出用于陶瓷加工的金属结合剂和树脂结合剂,金刚石磨具、金刚石烧结、焊接锯片;用于玻璃、青铜加工树脂相关结合剂磨边轮;用于磁性材料和硬质合金加工的金刚石砂轮;用于地质钻探、玻璃、石材、陶瓷加工的各种金刚石钻头;用于机械精密加工的陶瓷结合剂和树脂结合剂CBN砂轮。上述产品广泛用于硬质合金、钢铁、石材、陶瓷、玻璃、建材、磁性材料、石英晶体等各种金属材料和非金属材料的切割和磨削。

建厂以来,我们一贯重视对圆边抛光磨具的技术研究及科研开发的投入力度,每年均源源不断地开发出新的磨具产品,凭着雄厚的技术力量,务实的工作态度,严格的质量控制体系以及完善的售前售后服务,赢得了海内外广大用户的欢迎,产品远销国内及东南亚地区,成为国内,国外专业制造机械设备厂指定的配套产品。我公司以“质量是企业的生命”为宗旨,为广大客户提供一流的产品,一流的服务,欢迎来电来厂洽谈业务,我们期待着与您的合作。

Foshan Bowei Diamond Tools Co., Ltd. company has been successfully developed for the metallic bond and resinoid bond diamond grinding tools, diamond sintering and welding saw blade used for ceramics processing; bronze and resin bond used for glass processing, diamond wheel used for magnetic materials and hard alloy processing; all kinds of diamond bits used for geological drilling, glass, stone, ceramic processing; ceramics and resinoid bonded CBN wheel used for precision matching; the above products are widely used for cutting and grinding all kinds of metal materials and non-metallic materials, such as hard metal materials, steel, stone, ceramic, glass, building materials, magnetic materials, quartz crystal and so on.

Since the establishment of the factory, we have always attached great importance to the technical research and R & D investment on the round edge polishing abrasive. Every year, we continuously develop new abrasive products. With our strong technical force, pragmatic working attitude and strict Quality control system and improve the pre-market after-sales service, won the majority of users at home and abroad welcomed. the products are exported to China and Southeast Asia and Mideast. as domestic and foreign manufacturing machinery and equipment manufacturing plant designated ancillary products. My company to "The quality is the life of the enterprise" for the purpose, to provide our clients with first-class products, first-class service, welcomed the calls to plant business negotiations, and we look forward to working with you for your cooperation.



# 立足国内，走向全球 BASED IN CHINA, GOING GLOBAL

作为中国陶瓷磨具企业，  
煊威磨具以优良的品质不断赢得国内、国际市场的份额，  
目前产品出口已达20多个国家和地区。

As a Chinese ceramic Abrasives enterprises,  
Xuanwei Abrasives continuously win the share of domestic and international market with excellent quality.  
At present, its product export has reached more than 20 countries and regions.

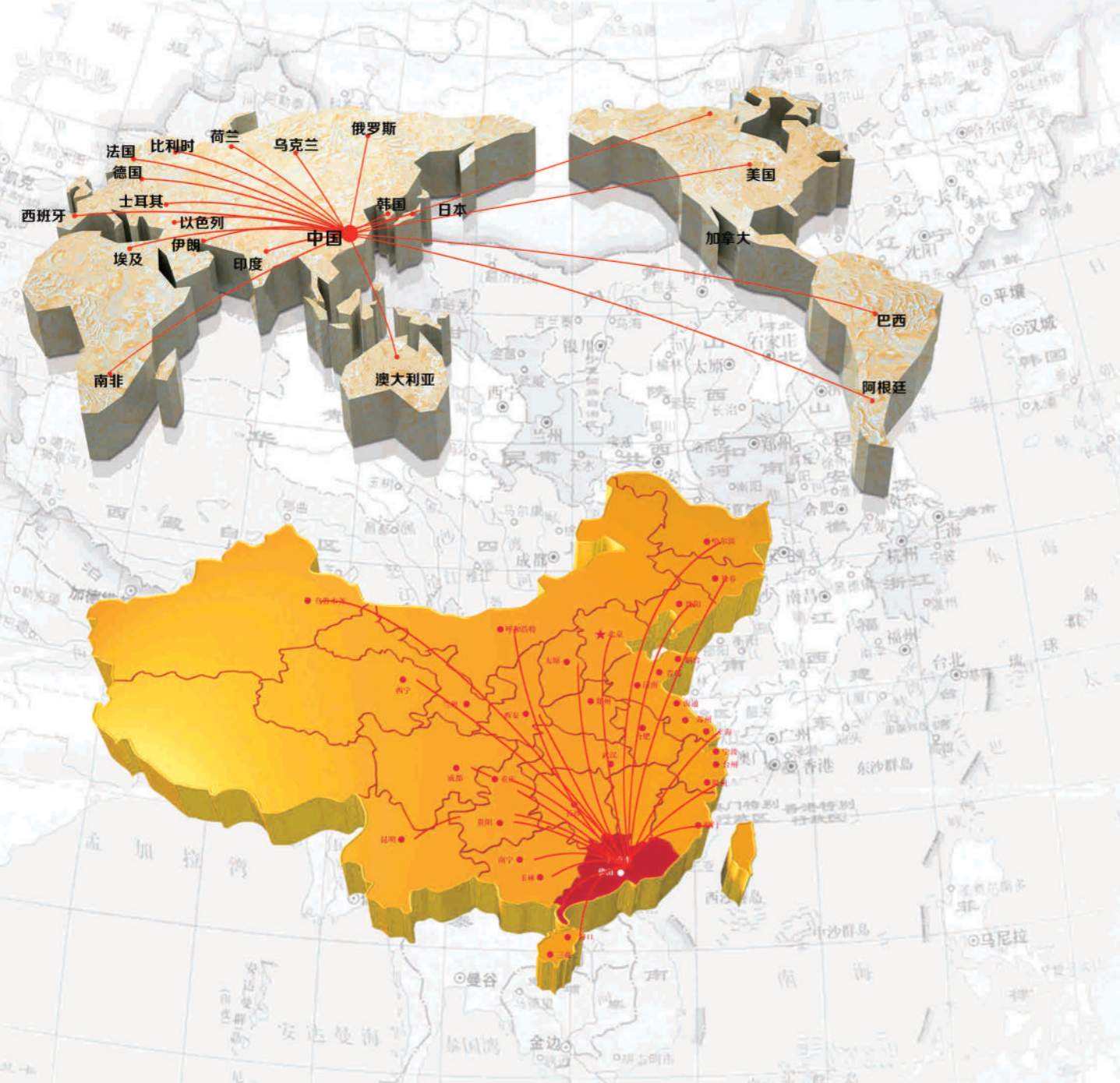



⊙ **岩板、陶瓷专用切割片** Special saw blade for cutting porcelain slab and ceramic tiles

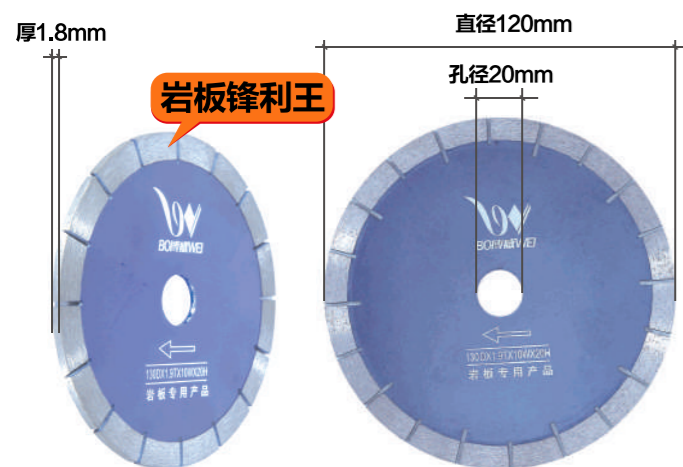

产品品牌：博威工具  
产品名称：金刚石切割片  
产品规格：直径120mmx孔径20mmx厚1.8mm  
使用范围：岩板、陶瓷、玻化砖、微晶石、大理石、花岗岩  
使用机型：云石机、角磨机

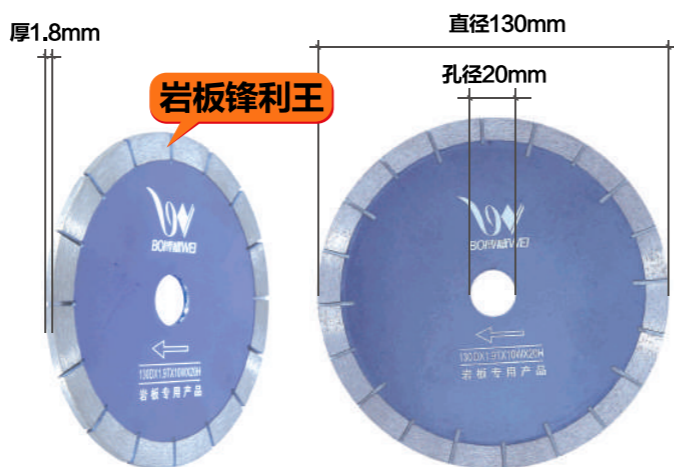

产品品牌：博威工具  
产品名称：金刚石切割片  
产品规格：直径130mmx孔径20mmx厚1.8mm  
使用范围：岩板、陶瓷、玻化砖、微晶石、大理石、花岗岩  
使用机型：云石机、角磨机

⊙ **岩板、陶瓷专用切割片** Special saw blade for cutting porcelain slab and ceramic tiles

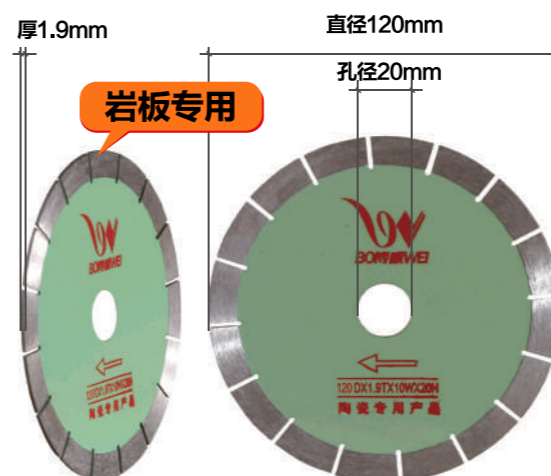

产品品牌：博威工具  
产品名称：金刚石切割片  
产品规格：直径120mmx孔径20mmx厚1.9mm  
使用范围：瓷砖、陶瓷、玻化砖、微晶石、大理石、岩板砖

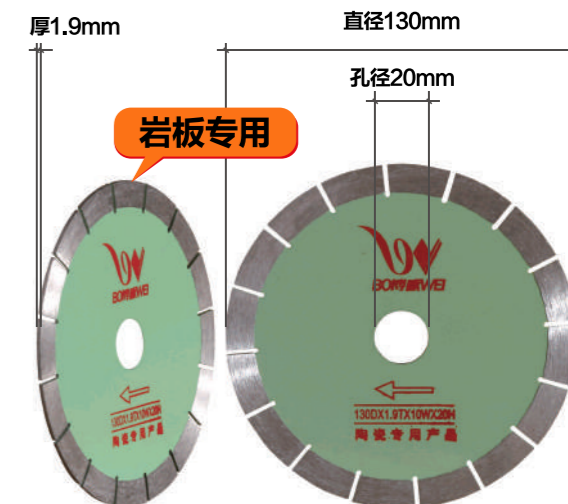

产品品牌：博威工具  
产品名称：金刚石切割片  
产品规格：直径130mmx孔径20mmx厚1.9mm  
使用范围：瓷砖、陶瓷、玻化砖、微晶石、大理石、岩板砖

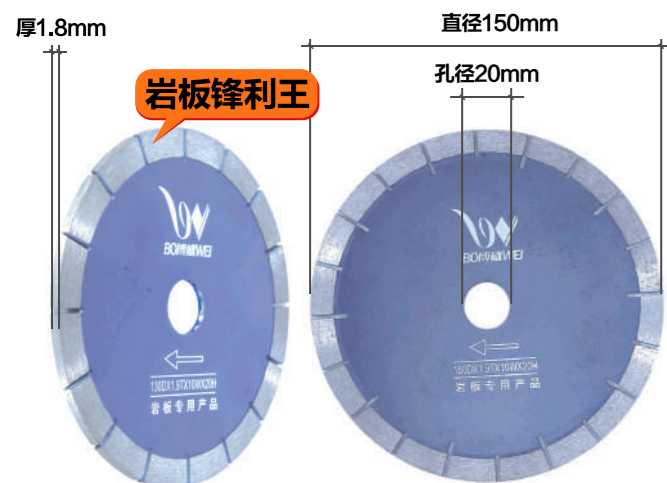

产品品牌：博威工具  
产品名称：金刚石切割片  
产品规格：直径150mmx孔径20mmx厚1.8mm  
使用范围：岩板、陶瓷、玻化砖、微晶石、大理石、花岗岩  
使用机型：云石机、角磨机

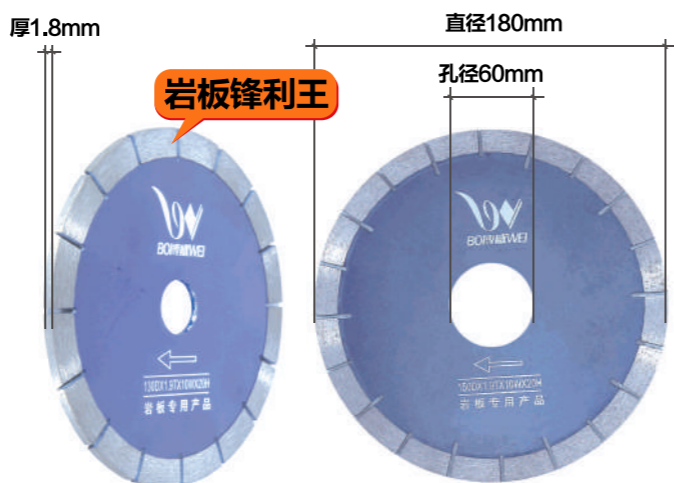

产品品牌：博威工具  
产品名称：金刚石切割片  
产品规格：直径180mmx孔径60mmx厚1.8mm  
使用范围：岩板、陶瓷、玻化砖、微晶石、大理石、花岗岩  
使用机型：云石机、角磨机

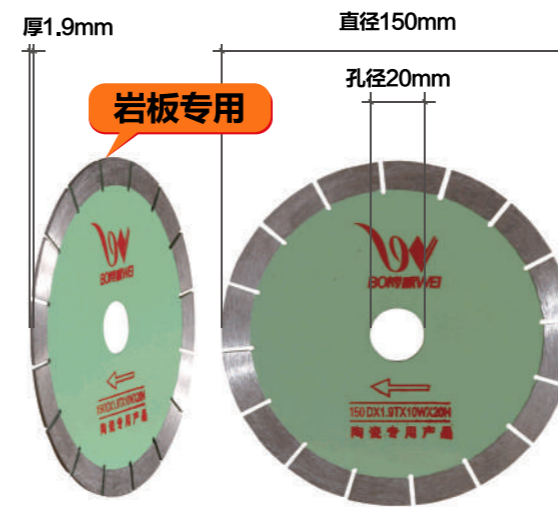

产品品牌：博威工具  
产品名称：金刚石切割片  
产品规格：直径150mmx孔径20mmx厚1.9mm  
使用范围：瓷砖、陶瓷、玻化砖、微晶石、大理石、岩板砖

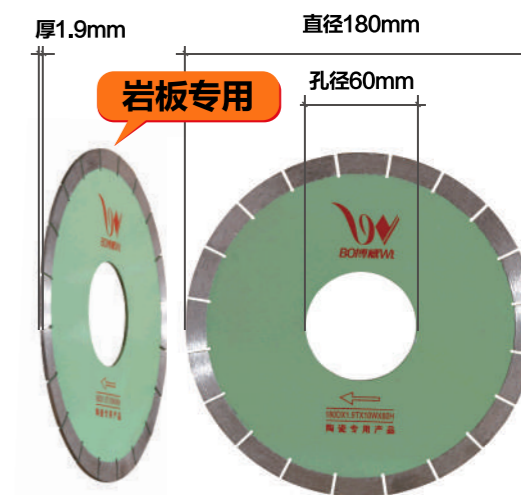

产品品牌：博威工具  
产品名称：金刚石切割片  
产品规格：直径180mmx孔径60mmx厚1.9mm  
使用范围：瓷砖、陶瓷、玻化砖、微晶石、大理石、岩板砖



◎ **岩板、陶瓷专用切割片** Special saw blade for cutting porcelain slab and ceramic tiles

◎ **岩板、大理石专用切割片** Special saw blade for cutting porcelain slab and ceramic tiles

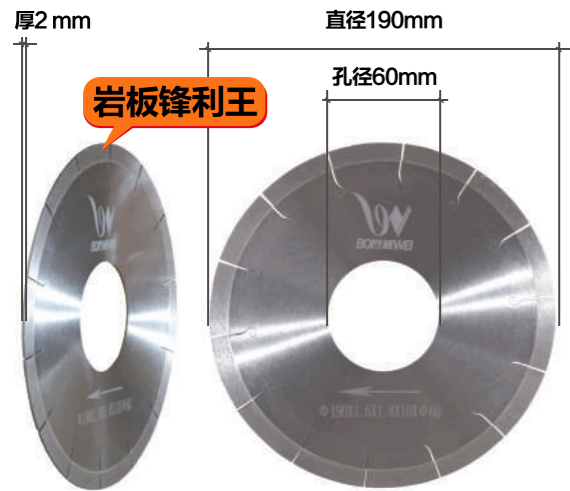

产品品牌: 博威工具  
产品名称: 金刚石切割片  
产品规格: 直径190mmx孔径60mmx厚1.9mm  
使用范围: 瓷砖、陶瓷、玻化砖、微晶石、大理石、岩板砖

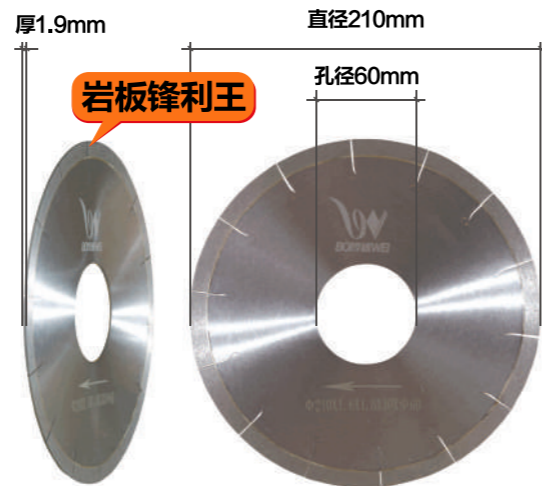

产品品牌: 博威工具  
产品名称: 金刚石切割片  
产品规格: 直径210mmx孔径60mmx厚1.9mm  
使用范围: 瓷砖、陶瓷、玻化砖、微晶石、大理石、岩板砖

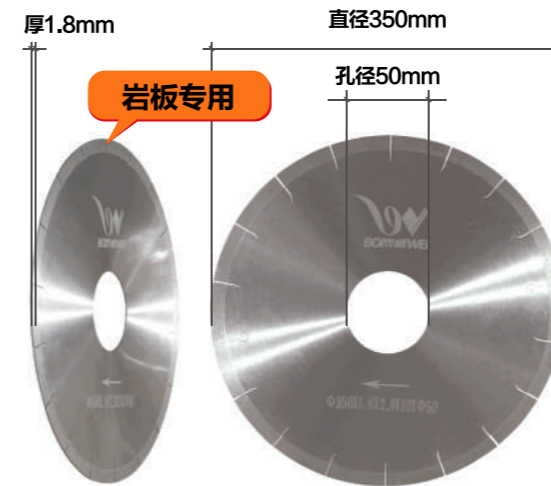

产品品牌: 博威工具  
产品名称: 金刚石切割片  
产品规格: 直径350mmx孔径50mmx厚1.8mm  
使用范围: 瓷砖、陶瓷、玻化砖、微晶石、大理石、岩板砖

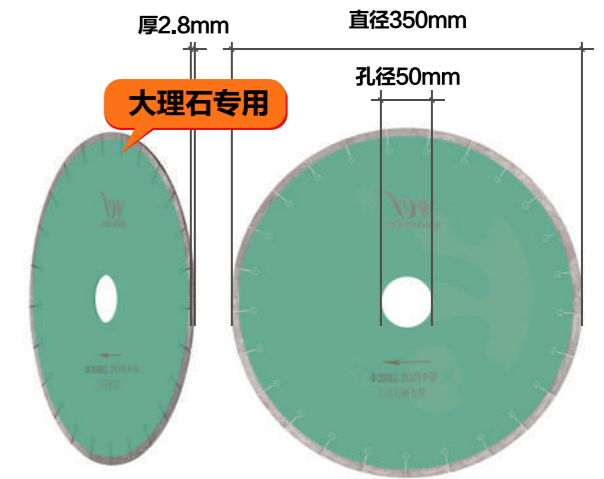

产品品牌: 博威工具  
产品名称: 金刚石切割片  
产品规格: 直径350mmx孔径50mmx厚2.8mm  
使用范围: 瓷砖、陶瓷、玻化砖、微晶石、大理石、岩板砖

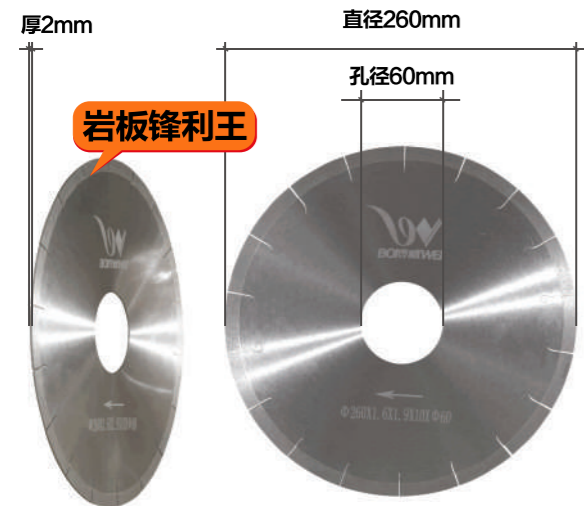

产品品牌: 博威工具  
产品名称: 金刚石切割片  
产品规格: 直径260mmx孔径60mmx厚2 mm  
使用范围: 瓷砖、陶瓷、玻化砖、微晶石、大理石、岩板砖

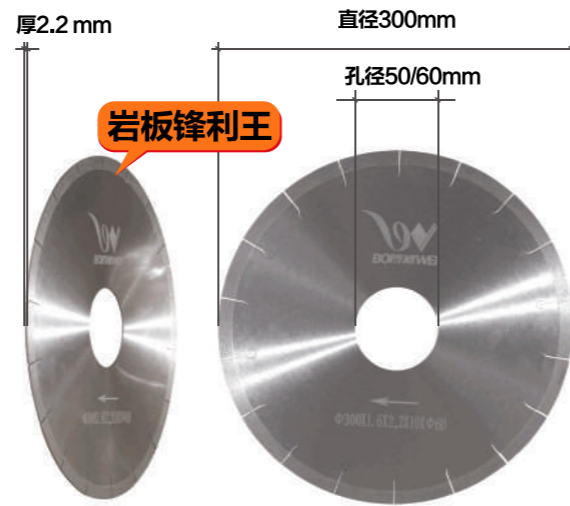

产品品牌: 博威工具  
产品名称: 金刚石切割片  
产品规格: 直径300mmx孔径50/60mmx厚2.2 mm  
使用范围: 瓷砖、陶瓷、玻化砖、微晶石、大理石、岩板砖

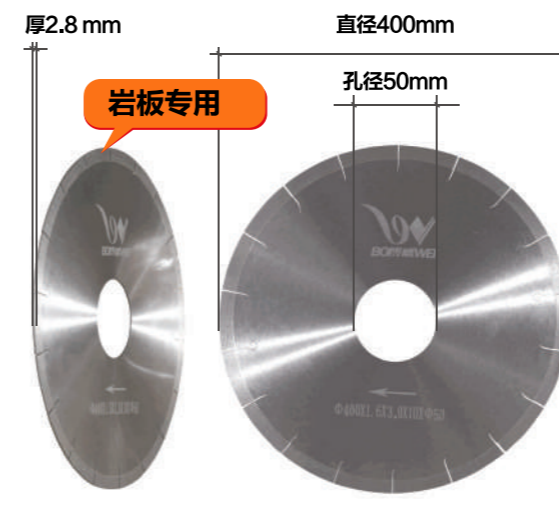

产品品牌: 博威工具  
产品名称: 金刚石切割片  
产品规格: 直径400mmx孔径50mmx厚2.8 mm  
使用范围: 瓷砖、陶瓷、玻化砖、微晶石、大理石、岩板砖

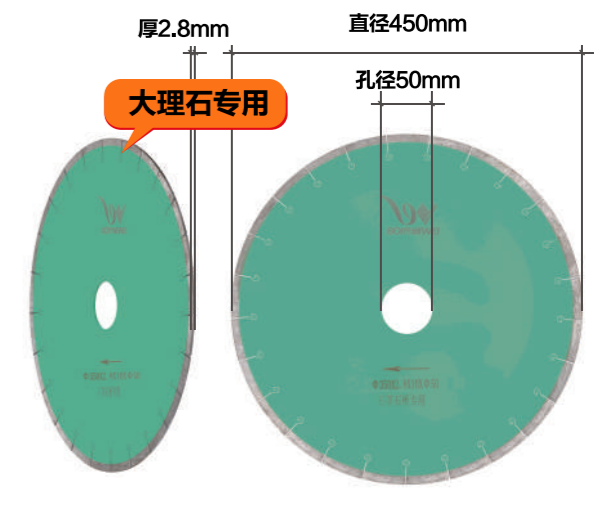

产品品牌: 博威工具  
产品名称: 金刚石切割片  
产品规格: 直径450mmx孔径50mmx厚2.8mm  
使用范围: 瓷砖、陶瓷、玻化砖、微晶石、大理石、岩板砖



◎ **Y3右旋圆边抛光磨具** Y3 right-handed round edge polishing abrasive

◎ **Y6 45° 专用抛光磨具/Y6圆边抛光磨具**  
Y6 45 degrees special polishing abrasive /Y6 round edge polishing abrasive.

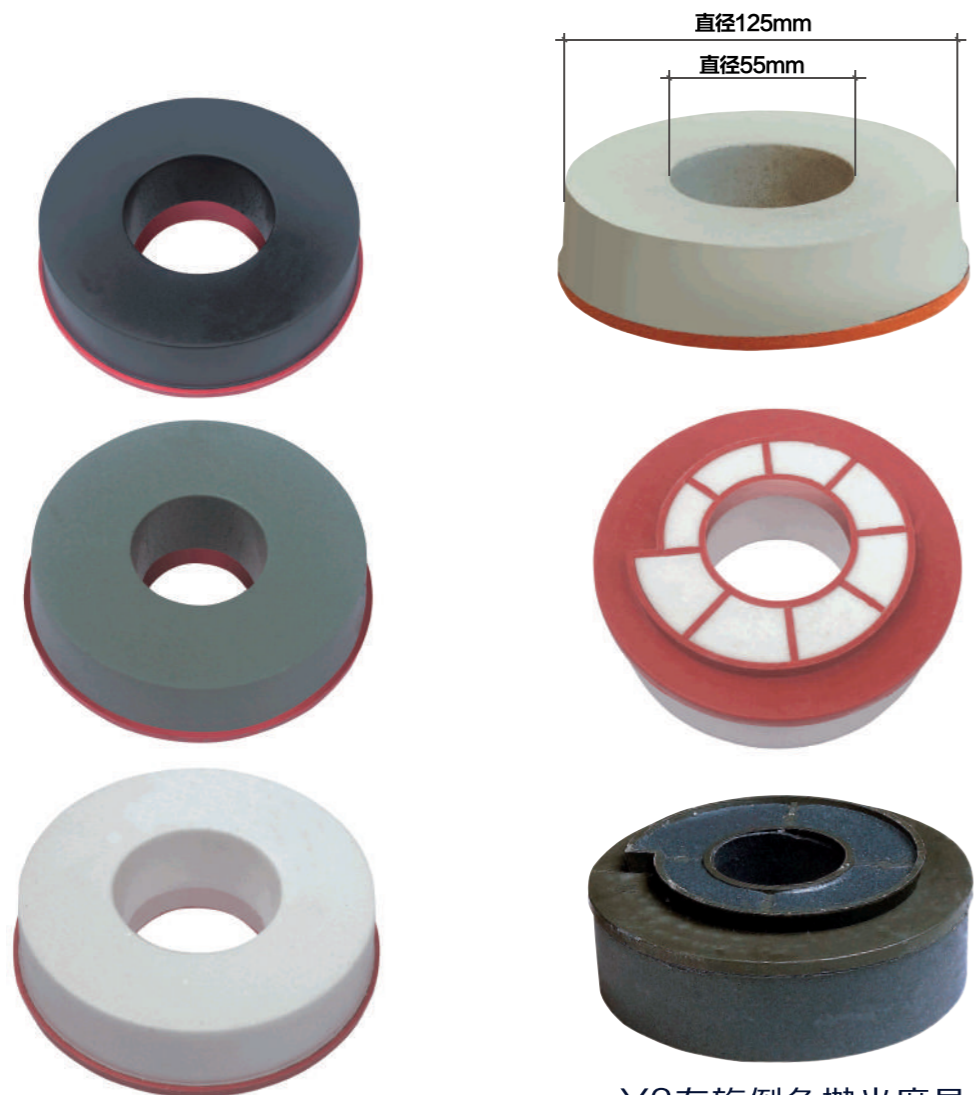

**Y3左旋倒角抛光磨具**  
Y3 lift-handed chamfer polishing abrasive

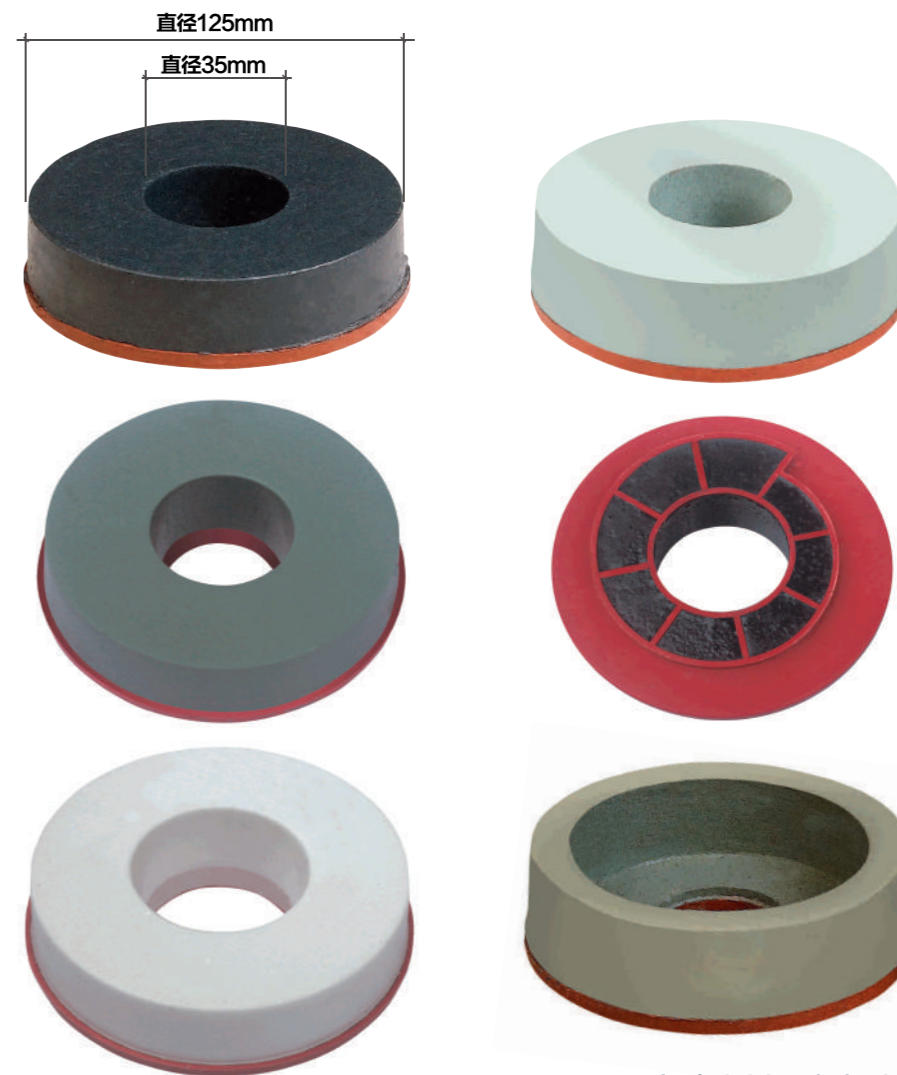

**Y6马赛克倒角抛光磨具**  
Y6 mosaic chamfering polishing abrasive.

磨具使用参数 Parameter of Abrasive

段别 Class	粒度 Grit	序号 Serial No.	使用压力 Working Pressure	使用寿命 Working Life
粗磨 Rough Grinding	180 <sup>#</sup> -240 <sup>#</sup>	1 <sup>#</sup> -2 <sup>#</sup>	0.5-2.0	90-150分钟
中磨 Medium Grinding	320 <sup>#</sup> -400 <sup>#</sup>	3 <sup>#</sup> -4 <sup>#</sup>	0.5-2.0	100-150分钟
精磨 Fine Grinding	600 <sup>#</sup> -800 <sup>#</sup>	6 <sup>#</sup> -8 <sup>#</sup>	0.5-2.0	120-180分钟
抛光 Polishing	1500 <sup>#</sup>	0 <sup>#</sup>	1.0-2.0	200-300分钟

产品耐磨度与工具的规划成正比，规格越大耐磨度越强  
Product wear resistance is proportional with the abrasive size.the abrasive size bigger is.the wear restance stronger more.

磨具使用参数 Parameter of Abrasive

段别 Class	粒度 Grit	序号 Serial No.	使用压力 Working Pressure	使用寿命 Working Life
粗磨 Rough Grinding	180 <sup>#</sup> -240 <sup>#</sup>	1 <sup>#</sup> -2 <sup>#</sup>	0.5-2.0	60-90分钟
中磨 Medium Grinding	320 <sup>#</sup> -400 <sup>#</sup>	3 <sup>#</sup> -4 <sup>#</sup>	0.5-2.0	90-120分钟
精磨 Fine Grinding	600 <sup>#</sup> -800 <sup>#</sup>	6 <sup>#</sup> -8 <sup>#</sup>	0.5-2.0	120-180分钟
抛光 Polishing	1500 <sup>#</sup>	0 <sup>#</sup>	1.0-2.0	200-250分钟

产品耐磨度与磨具的规划成正比，规格越大耐磨度越强  
Product wear resistance is proportional with the abrasive size.the abrasive size bigger is.the wear restance stronger more.



树脂结合开槽轮 Resin bonded grooved wheel

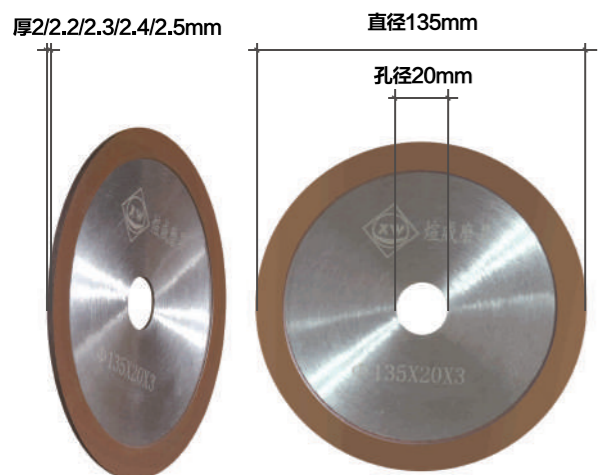

产品品牌: 煊威磨具  
产品名称: 树脂结合开槽轮  
产品规格: 直径150mmx孔径20mmx厚2.2/2.3/2.4/2.5mm  
使用范围: 瓷砖、陶瓷、玻化砖、微晶石、大理石、岩板砖

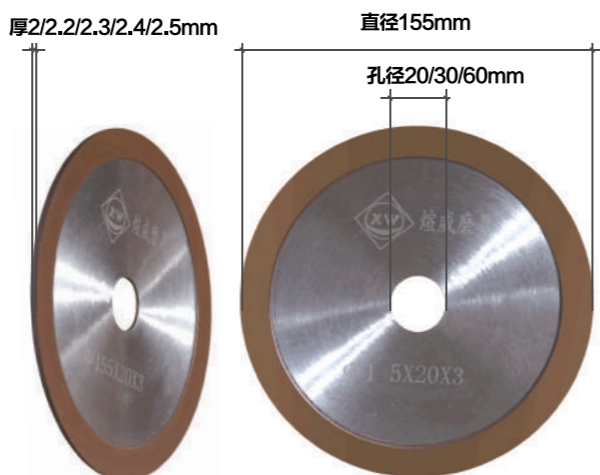

产品品牌: 煊威磨具  
产品名称: 树脂结合开槽轮  
产品规格: 直径155mmx孔径20/30/60mmx厚2.2/2.3/2.4/2.5mm  
使用范围: 瓷砖、陶瓷、玻化砖、微晶石、大理石、岩板砖

树脂结合开槽轮 Resin bonded grooved wheel

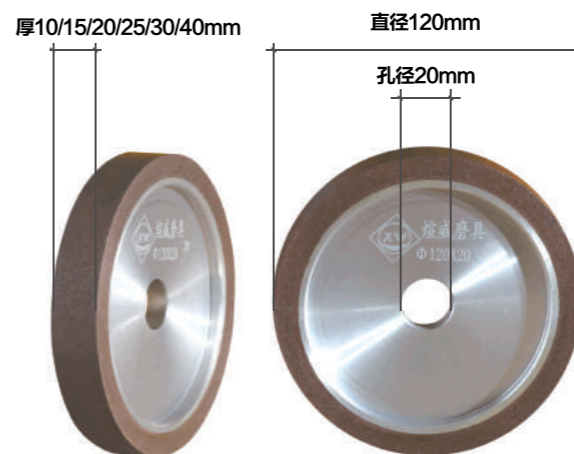

产品品牌: 煊威磨具  
产品名称: 树脂结合轮  
产品规格: 直径120mmx孔径20mmx厚10/15/20/25/30/40mm  
使用范围: 瓷砖、陶瓷、玻化砖、微晶石、大理石、岩板砖

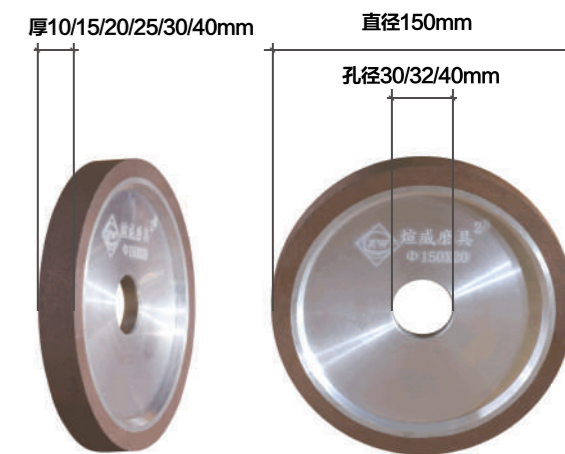

产品品牌: 煊威磨具  
产品名称: 树脂结合轮  
产品规格: 直径155mmx孔径30/32/40mmx厚10/15/20/25/30/40mm  
使用范围: 瓷砖、陶瓷、玻化砖、微晶石、大理石、岩板砖

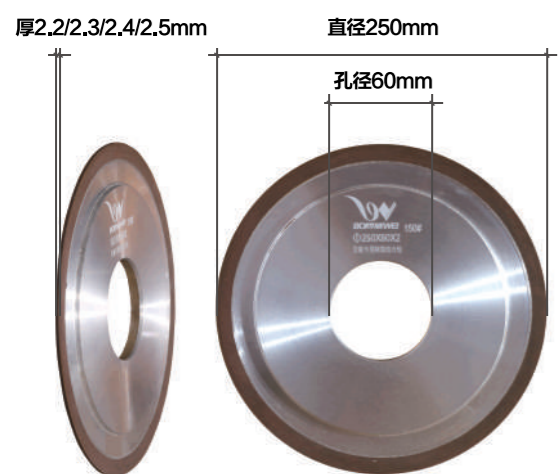

产品品牌: 煊威磨具  
产品名称: 树脂结合开槽轮  
产品规格: 直径300mmx孔径50mmx厚2.2/2.3/2.4/2.5mm  
使用范围: 瓷砖、陶瓷、玻化砖、微晶石、大理石、岩板砖

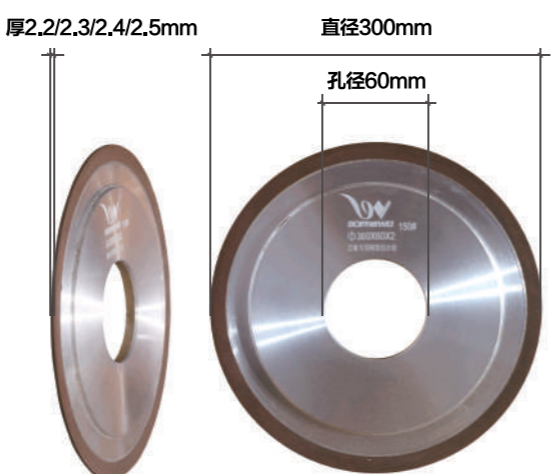

产品品牌: 煊威磨具  
产品名称: 树脂结合开槽轮  
产品规格: 直径300mmx孔径50mmx厚2.2/2.3/2.4/2.5mm  
使用范围: 瓷砖、陶瓷、玻化砖、微晶石、大理石、岩板砖

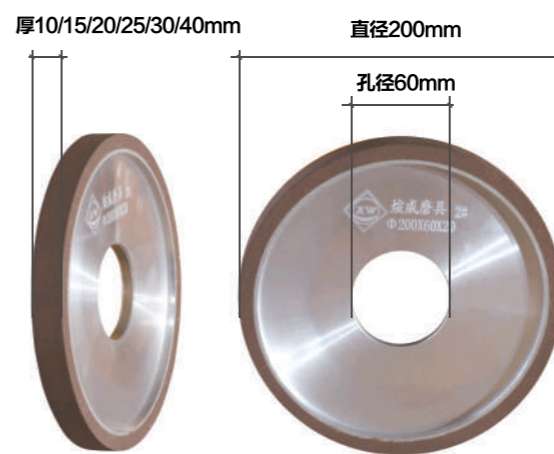

产品品牌: 煊威磨具  
产品名称: 树脂结合轮  
产品规格: 直径200mmx孔径60mmx厚10/15/20/25/30/40mm  
使用范围: 瓷砖、陶瓷、玻化砖、微晶石、大理石、岩板砖

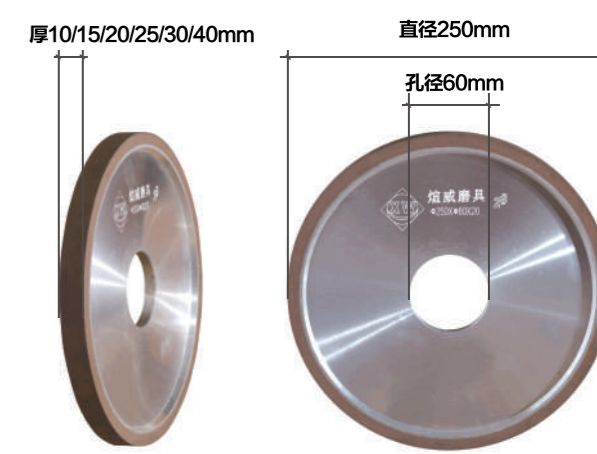

产品品牌: 煊威磨具  
产品名称: 树脂结合轮  
产品规格: 直径250mmx孔径60mmx厚10/15/20/25/30/40mm  
使用范围: 瓷砖、陶瓷、玻化砖、微晶石、大理石、岩板砖



① **金刚石磨轮** Diamond grinding wheel

① **金刚石磨轮** Diamond grinding wheel

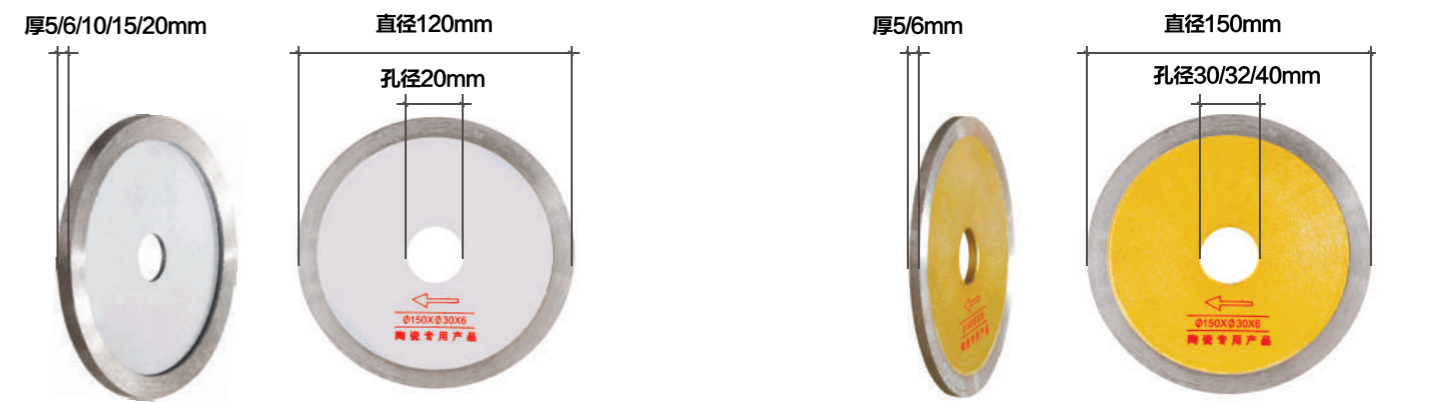
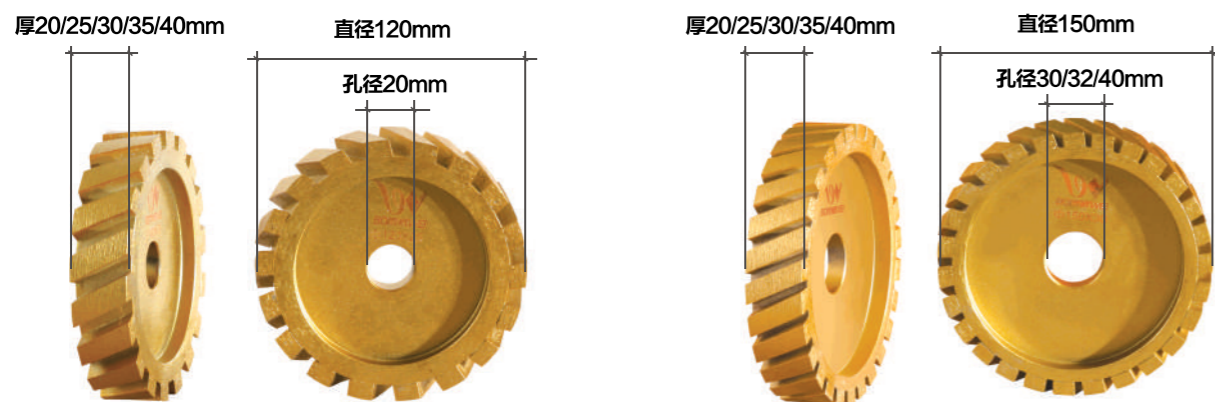
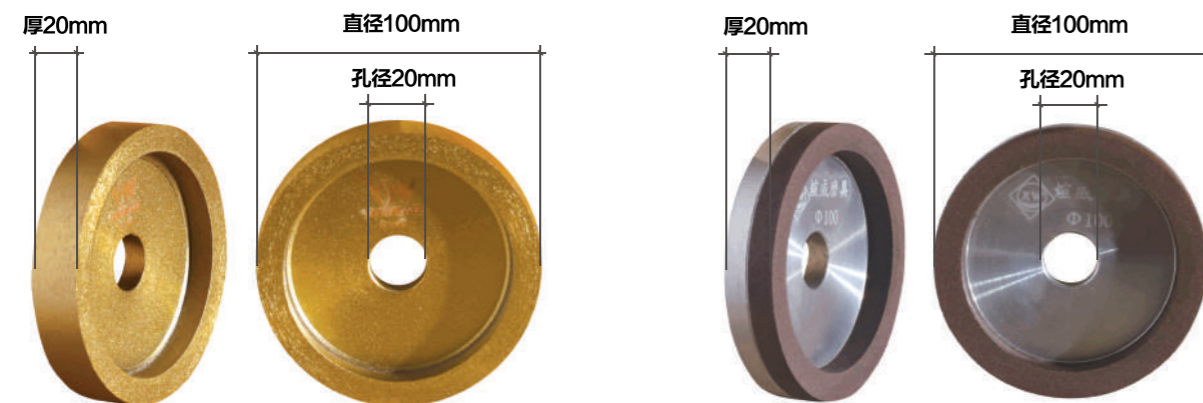



## ① 金刚石磨轮 Diamond grinding wheel

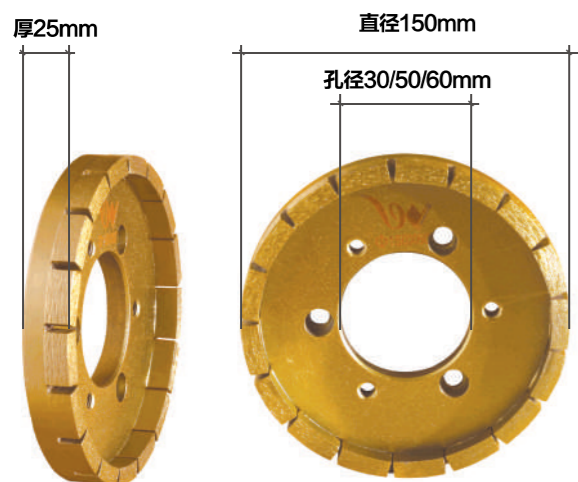

产品品牌: 博威工具  
产品名称: 金刚石修边轮  
产品规格: 直径150mmx孔径30/50/60x厚25mm  
使用范围: 瓷砖、陶瓷、玻化砖、微晶石、大理石、岩板砖

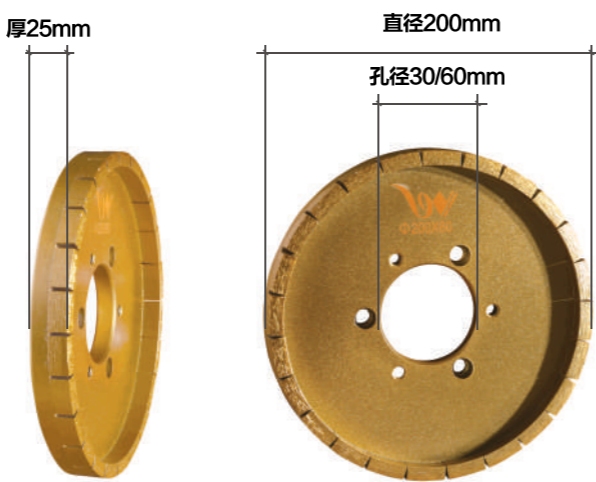

产品品牌: 博威工具  
产品名称: 金刚石修边轮  
产品规格: 直径200mmx孔径30/60mmx厚25mm  
使用范围: 瓷砖、陶瓷、玻化砖、微晶石、大理石、岩板砖

## ① 金刚石磨轮 Diamond grinding wheel

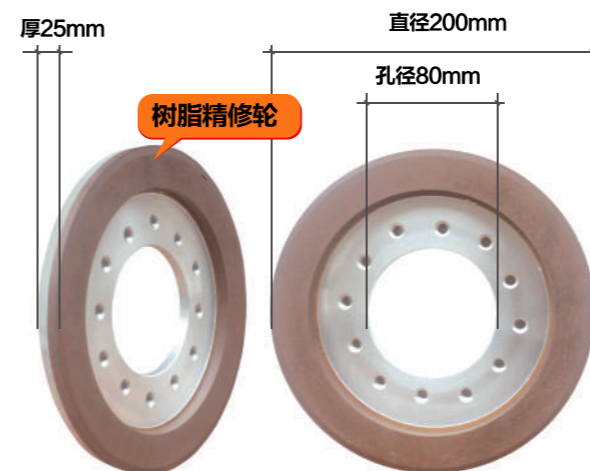

产品品牌: 博威工具  
产品名称: 树脂结合轮  
产品规格: 直径200mmx孔径80mmx厚25mm  
使用范围: 瓷砖、陶瓷、玻化砖、微晶石、大理石、岩板砖

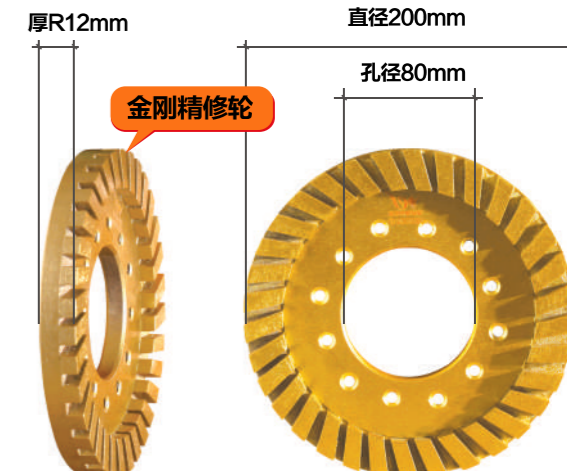

产品品牌: 博威工具  
产品名称: 金刚石精修轮  
产品规格: 直径200mmx孔径80mmx厚R25mm  
使用范围: 瓷砖、陶瓷、玻化砖、微晶石、大理石、岩板砖

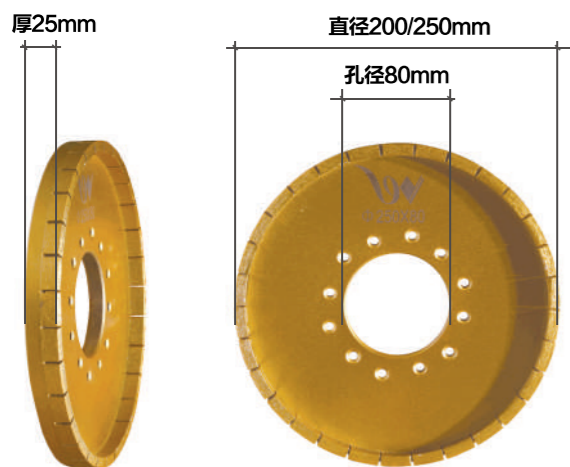

产品品牌: 博威工具  
产品名称: 金刚石修边轮  
产品规格: 直径200/250mmx孔径80mmx厚25mm  
使用范围: 瓷砖、陶瓷、玻化砖、微晶石、大理石、岩板砖

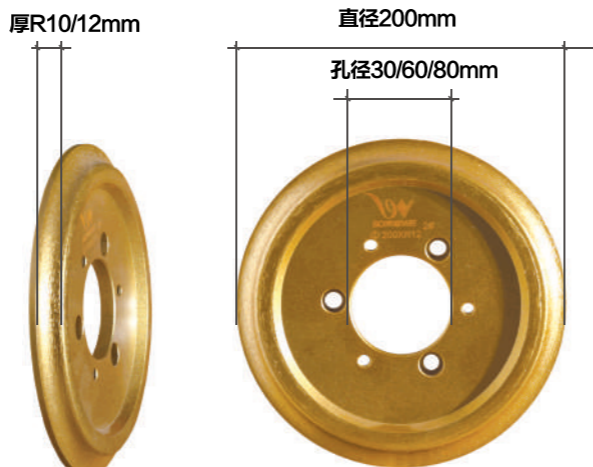

产品品牌: 博威工具  
产品名称: 陶瓷圆角轮  
产品规格: 直径200mmx孔径30/60/80mmx厚R10/12mm  
使用范围: 瓷砖、陶瓷、玻化砖、微晶石、大理石、岩板砖

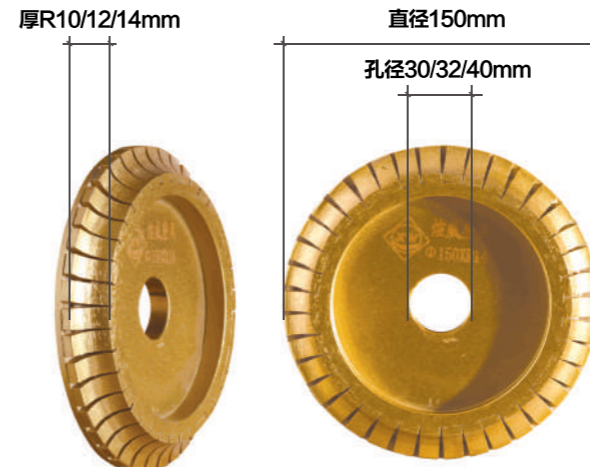

产品品牌: 博威工具  
产品名称: 金刚石法国边磨轮  
产品规格: 直径150mmx孔径30/32/40mmx厚R10/12/14mm  
使用范围: 瓷砖、陶瓷、玻化砖、微晶石、大理石、岩板砖

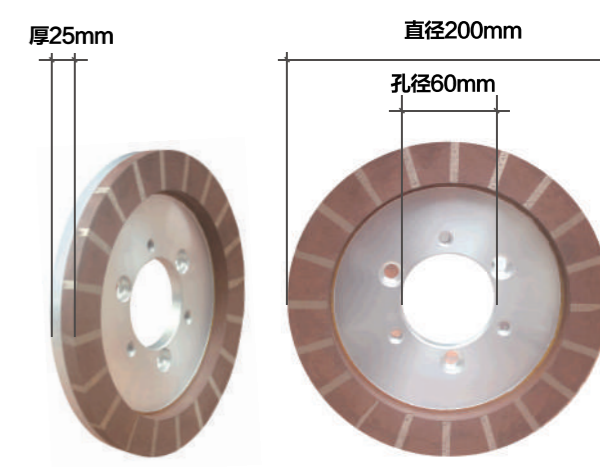

产品品牌: 博威工具  
产品名称: 金刚树脂复合轮  
产品规格: 直径200mmx孔径60x厚25mm  
使用范围: 瓷砖、陶瓷、玻化砖、微晶石、大理石、岩板砖



青铜结合玻璃轮 Bronze bonded glass wheel

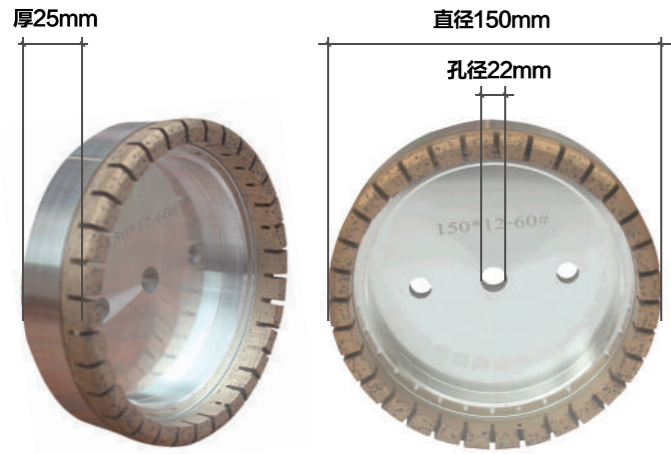

产品品牌：博威工具  
产品名称：青铜结合玻璃轮  
产品规格：直径150mmx孔径22mmx厚25mm  
使用范围：瓷砖、陶瓷、玻化砖、微晶石、大理石、岩板砖

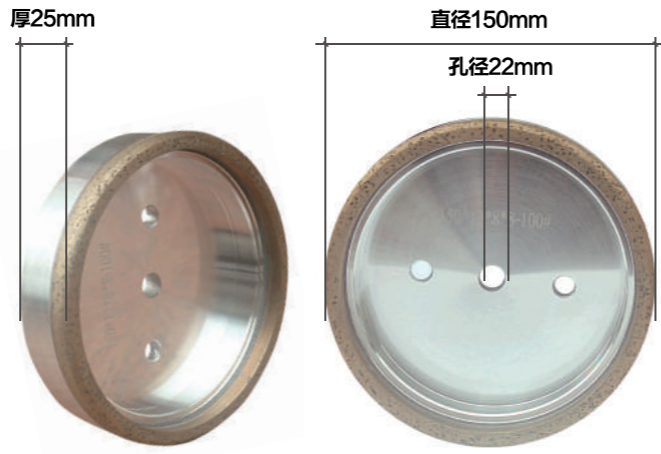

产品品牌：博威工具  
产品名称：青铜结合玻璃轮  
产品规格：直径150mmx孔径22mmx厚25mm  
使用范围：瓷砖、陶瓷、玻化砖、微晶石、大理石、岩板砖

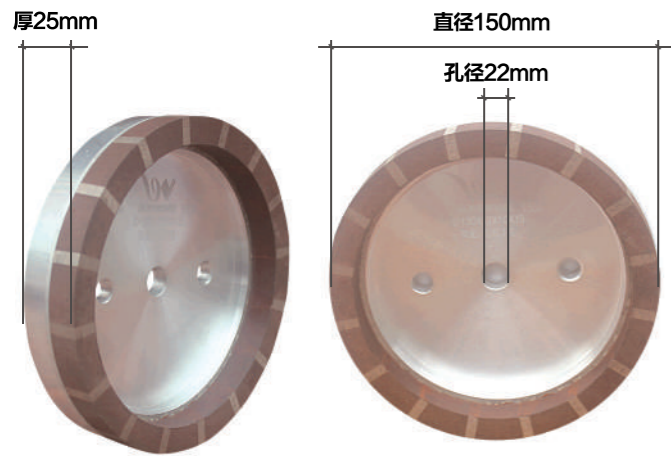

产品品牌：博威工具  
产品名称：金刚树脂复合轮  
产品规格：直径150mmx孔径22mmx厚25mm  
使用范围：瓷砖、陶瓷、玻化砖、微晶石、大理石、岩板砖

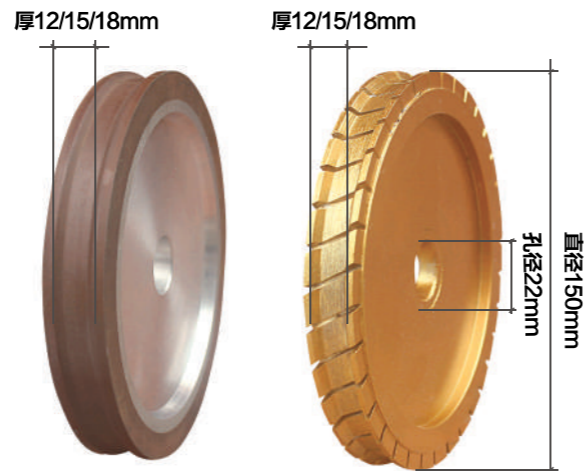

产品品牌：博威工具  
产品名称：岩板倒角轮  
产品规格：直径150mmx孔径22mmx厚12/15/18mm  
使用范围：瓷砖、陶瓷、玻化砖、微晶石、大理石、岩板砖

各种卫浴磨边为您量身定做  
All kinds of bathroom edging are tailor-made for you

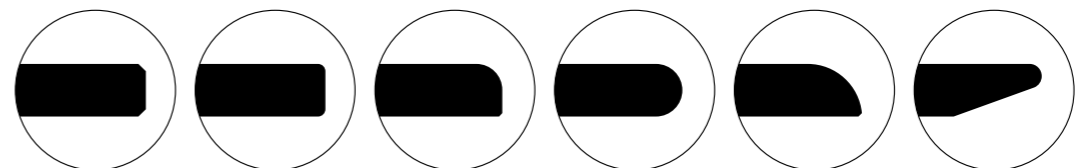



## ◎ 岩板、石材成型抛光复合轮 Stone shaping and polishing wheel

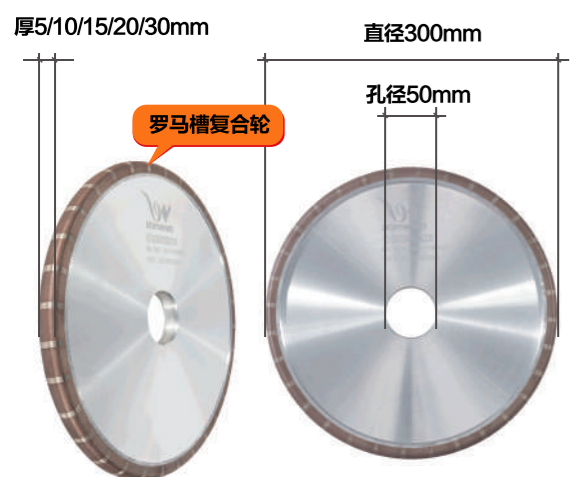

产品品牌: 博威工具  
产品名称: 金刚树脂复合轮  
产品规格: 直径300mmx孔径50mmx厚5/10/15/20/30mm  
使用范围: 岩板、陶瓷、玻化砖、微晶石、大理石、花岗岩



产品品牌: 博威工具  
产品名称: 金刚树脂复合轮  
产品规格: 直径300mmx孔径50mmx厚5/10/15/20/30mm  
使用范围: 岩板、陶瓷、玻化砖、微晶石、大理石、花岗岩

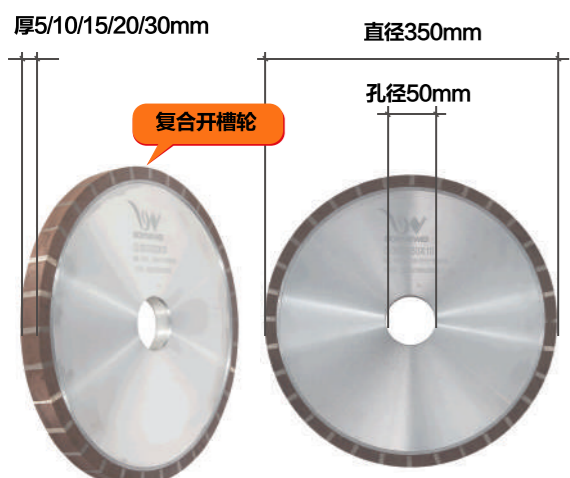

产品品牌: 博威工具  
产品名称: 金刚树脂复合轮  
产品规格: 直径350mmx孔径50mmx厚5/10/15/20/30mm  
使用范围: 岩板、陶瓷、玻化砖、微晶石、大理石、花岗岩

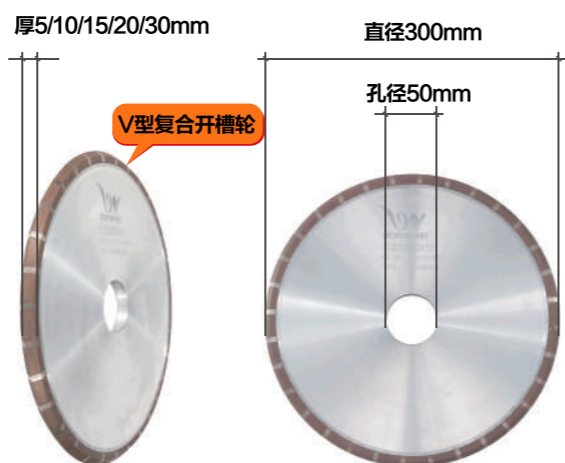

产品品牌: 博威工具  
产品名称: V金刚树脂复合轮  
产品规格: 直径300mmx孔径50mmx厚5/10/15/20/30mm  
使用范围: 岩板、陶瓷、玻化砖、微晶石、大理石、花岗岩

## ◎ 石材成型抛光一体轮 Stone shaping and polishing wheel



产品品牌: 博威工具  
产品名称: 树脂开槽轮  
产品规格: 直径300mmx孔径50mmx厚5mm  
使用范围: 岩板、陶瓷、玻化砖、微晶石、大理石、花岗岩

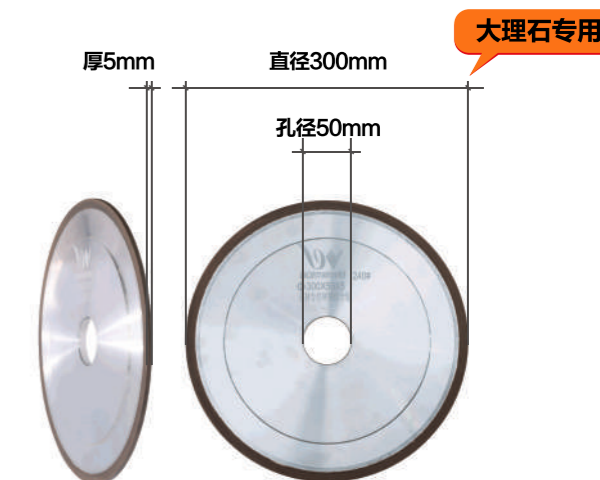

产品品牌: 博威工具  
产品名称: 树脂开槽轮  
产品规格: 直径300mmx孔径50mmx厚5mm  
使用范围: 岩板、陶瓷、玻化砖、微晶石、大理石、花岗岩



产品品牌: 博威工具  
产品名称: 树脂开槽轮  
产品规格: 直径300mmx孔径50mmx圆角10mm  
使用范围: 岩板、陶瓷、玻化砖、微晶石、大理石、花岗岩

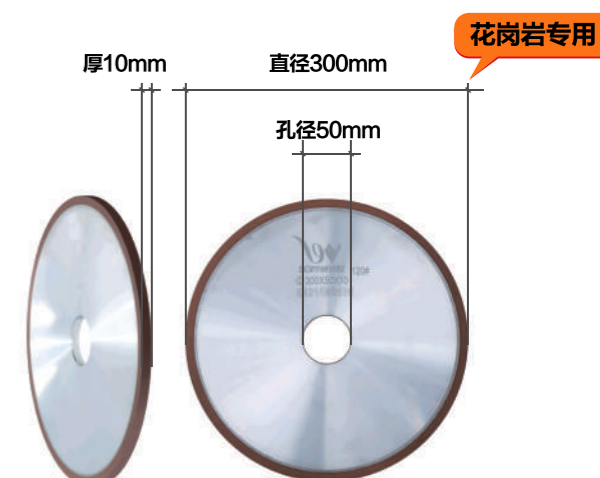

产品品牌: 博威工具  
产品名称: 树脂开槽轮  
产品规格: 直径300mmx孔径50mmx厚10mm  
使用范围: 岩板、陶瓷、玻化砖、微晶石、大理石、花岗岩



## ◎ 岩板、石材异型抛光一体轮 Stone shaping and polishing wheel

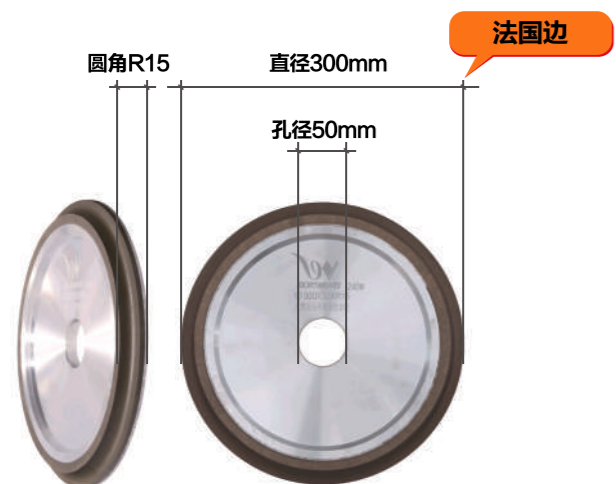

法国边

产品品牌: 博威工具  
产品名称: 树脂法国边  
产品规格: 直径300mmx孔径50mmx圆角R15  
使用范围: 岩板、陶瓷、玻化砖、微晶石、大理石、花岗岩



石材专用

产品品牌: 博威工具  
产品名称: 石材异型、成型抛光轮  
产品规格: 直径300mmx孔径50mmx厚30mm  
使用范围: 岩板、陶瓷、玻化砖、微晶石、大理石、花岗岩



石材专用

产品品牌: 博威工具  
产品名称: 石材异型、成型抛光轮  
产品规格: 直径300mmx孔径50mmx厚30mm  
使用范围: 岩板、陶瓷、玻化砖、微晶石、大理石、花岗岩



石材专用

产品品牌: 博威工具  
产品名称: 石材异型、成型抛光轮  
产品规格: 直径300mmx孔径50mmx厚30mm  
使用范围: 岩板、陶瓷、玻化砖、微晶石、大理石、花岗岩

## 各种金刚树脂复合轮可为您量身定做

All kinds of resin bonded special shaped wheels, can be customized for you.

各种线条轮, 异型轮, 主要用于石材, 陶瓷, 人造岗石的各种艺术线生产, 可配套各种自动线条机。  
All kinds of line wheels, shaped wheels, mainly used for stone, ceramics, artificial stone production of various art line, supporting a variety of automatic line machine.





### 各种树脂结合异型轮可为您量身定做

All kinds of resin bonded special shaped wheels, can be customized for you.

各种线条轮，异型轮，主要用于石材，陶瓷，人造岗石的各种艺术线生产，可配套各种自动线条机。  
All kinds of line wheels, shaped wheels, mainly used for stone, ceramics, artificial stone production of various art line, supporting a variety of automatic line machine.



### 各种异型电镀成型轮可为您量身定做

All kinds of special shaped plating shapping wheels can be customized for you.

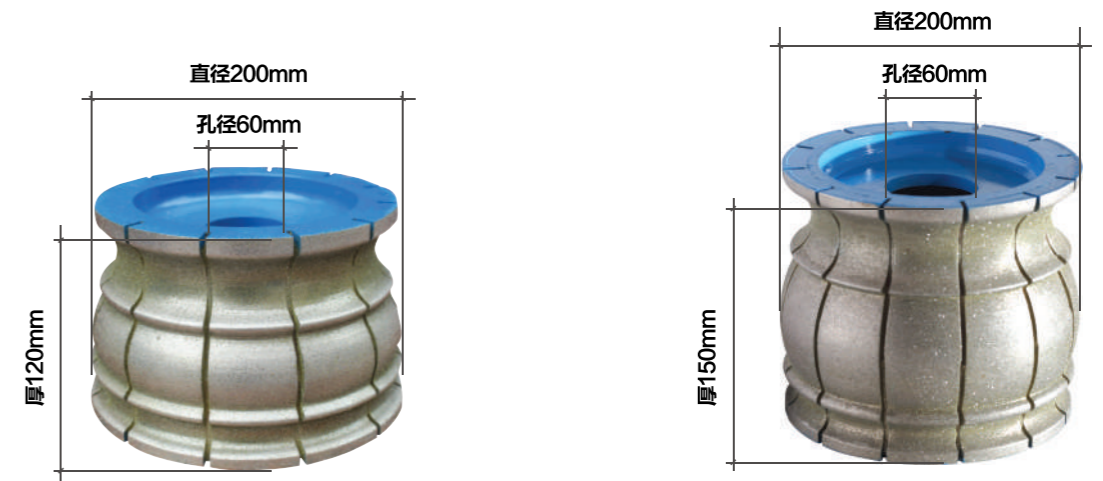



### 各种异型烧结轮可为您量身定做

All kinds of special shaped wheels of sintering can be customized for you.

各种线条轮，异型轮，主要用于石材，陶瓷，人造岗石的各种艺术线生产，可配套各种自动线条机。  
All kinds of line wheels, shaped wheels, mainly used for stone, ceramics, artificial stone production of various art line, supporting a variety of automatic line machine.

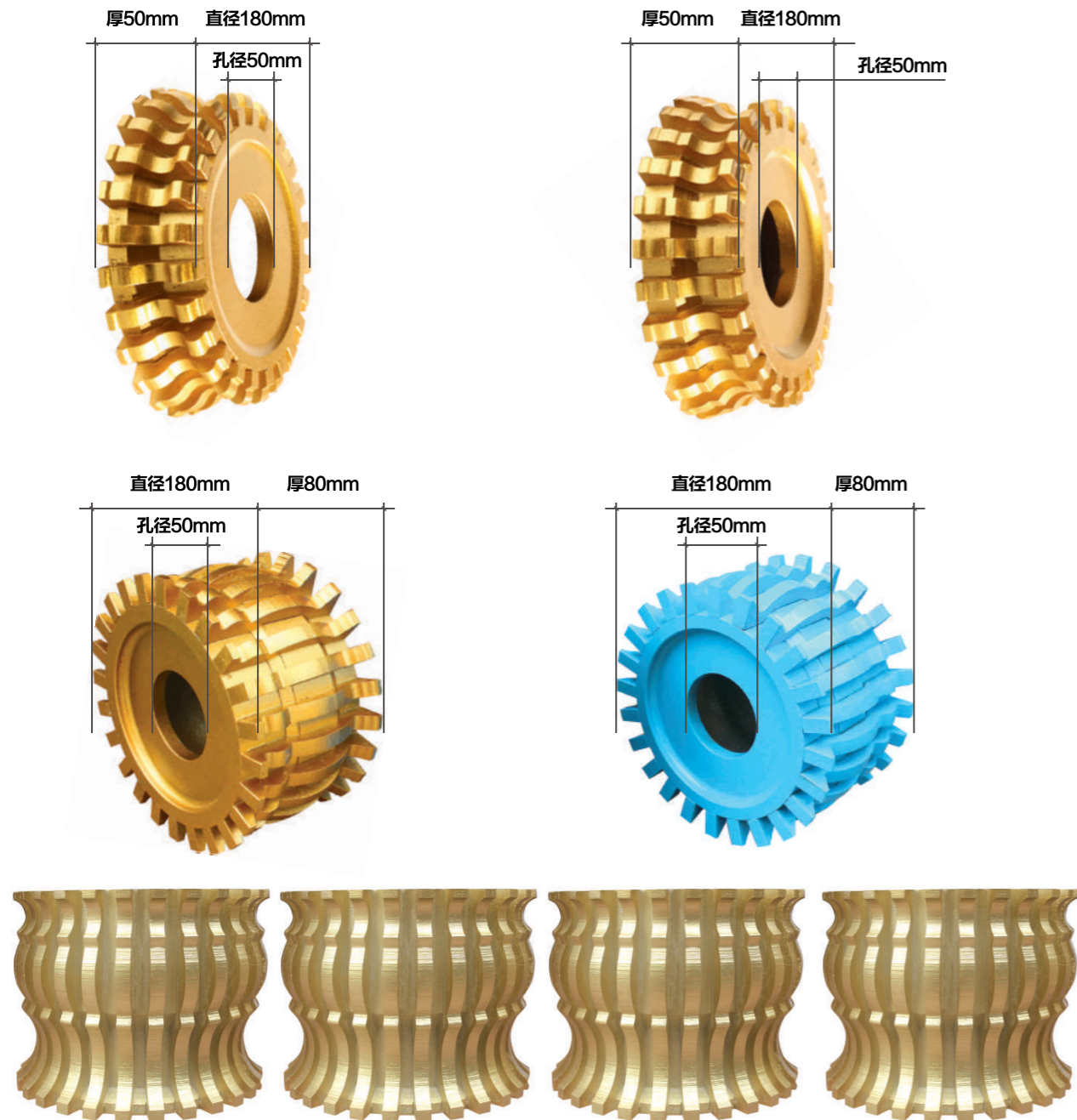

### 金刚成型轮及树脂成型轮异型轮可为您量身定做

Diamond shapping wheel and resin shapping wheel can be customized for you.





### 加工中心机械专用轮

Special wheel for machinery in processing center



### 加工中心锣刀专用可为您量身定做

The milling cutter is specially used in processing center can be customized for you.





各种异型抛光磨具可为您量身定做

All kinds of special-shaped polishing abrasives can be customized for you.

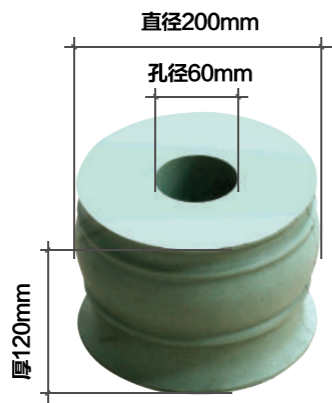
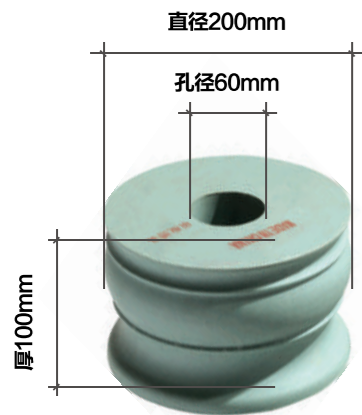
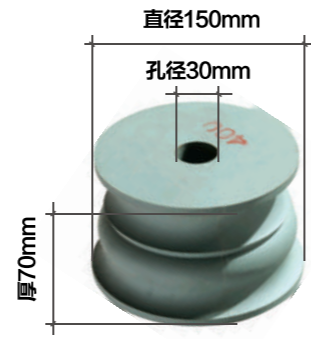
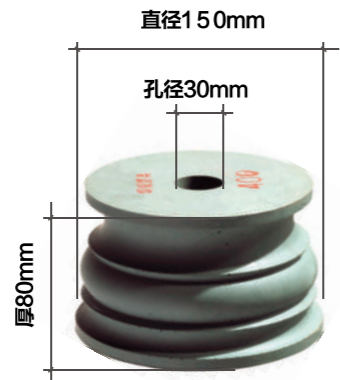
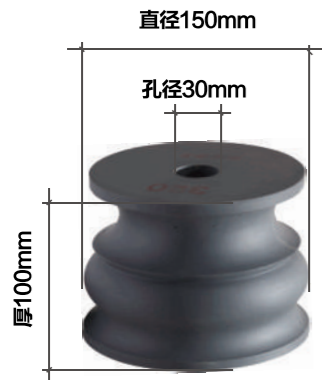

海绵抛光轮  
Sponge polishing wheel



海绵抛光轮  
Sponge polishing wheel

