



SIP-T790 / T790 (P/G/W/K) User Manual



Copyright

Copyright © 2020 LVswitch (Guangdong) Information Technology Co., Ltd. Copyright, all rights reserved.

Without the express written permission of LVswitch (Guangdong) Information Technology Co., Ltd., no unit or individual may copy, copy or translate part or all of this manual without authorization.

It shall not be used in any form or any method (electronic, video, printing or other methods) for commercial purposes, profit purposes, and LVswitch (Guangdong) Information Technology Co., Ltd. will not bear any responsibility for any property or other losses caused by illegal actions. .

When this document is used for network dissemination, the company allows users to download or print it for private use.

Guarantee

The product specifications and consultations mentioned in this manual are for reference only, and will not be notified if the content is updated. Unless there is a special agreement, this manual is only used as a guide, try to provide the most accurate statements, information and suggestions, and does not guarantee any express or implied structure. The user shall bear full responsibility for the application of the product.

LVswitch (Guangdong) Information Technology Co., Ltd. does not make any guarantees for this guide, including but not limited to implied merchantability and special purpose guarantees. LVswitch (Guangdong) Information Technology Co., Ltd. shall not be liable for any indirect or incidental losses caused by incorrect use of this guide.

Statement



This equipment complies with the basic requirements of CE, FCC and other relevant regulations. You can view the CE and FCC information on the label on the back of the phone.

CE mark

This device complies with the European Union's safety directive 2014/35/EU and electromagnetic compatibility directive 2014/30/EU.

Part 15 of FCC Regulations

The device complies with Part 15 of the FCC regulations. The following two requirements should be followed when working.

1. The device will not cause harmful interference.
2. This device must accept any interference received, including interference that may cause unintended operation.

WEEE Mark

Since electronic products contain certain hazardous substances, in order to properly dispose of these electronic and electrical wastes and at the same time recover precious resources, when users intend to discard this product, it should not be discarded with other household wastes, and should be treated



Customer Feedback

We are working hard to improve the quality of the documentation and would love to receive your feedback. If you have any suggestions or questions about the content of the document, please send your feedback to the following mailbox: pan.jiandong@lvswitches.com.

Writing purpose

Thanks for using the T790 IP phone. SIP-T790 is a simple office phone with rich functions. In addition, it also has high-definition sound quality, unique appearance design, multi-language interchange; supports dual network ports, POE power supply; compatible with many manufacturers' service platforms, such as IPPBX , Cloud PBX, IMS core network, softswitch, etc.; the detachable bracket can have multiple viewing angles, 2 customizable function buttons and a friendly user interface fully meet the needs of users for communication and collaboration.

SIP-T790/SIP-T790 (P/G/W/K) use the same firmware, the software functions are the same, and the difference lies in the hardware. The following table describes the differences between these hardware.

Product model	Specification
SIP-T790	Normal version
SIP-T790(P/G/W/K)	P (With PoE supply) G (Carry Gigabit Ethernet port) W (Carry WIFI module) K (Carry expansion module external network port)

This guide contains all the functions of the phone and instructions for use, so that users can be familiar with the functions of the T790 IP phone. Before installing the phone, please read the safety instructions and the contents of the packing list in this guide to use the phone safely and quickly.

For more help, please contact your network administrator or dealer.

Outline

This guide contains the following:

- [1.Outline](#)
- [2.Notes for safe use](#)
- [3.Getting started with the Phone](#)
- [4.Phone customization](#)
- [5.Basic Function](#)
- [6.Advanced Features](#)

Catalog

Copyright	2
Guarantee	2
Statement	2
CE mark	2
Part 15 of FCC Regulations	2
WEEE Mark	3
Customer Feedback	3
Writing purpose	4
Outline	4
Catalog	5
1. Outline	8
1.1 Hardware composition	8
1.2 Display icon description	10
1.3 Indicators Description	11
1.4 Configuration interface description	11
1.4.1 Phone LCD Configuration	11
1.4.2 Web interface configuration	11
1.4.3 Mobile phone scan code configuration	12
1.5 Usage Documentation	14
2. Notes for safe use	15
3. Getting started with the phone	16
3.1 Packing list	16
3.2 Phone installation	18
3.2.1 Install the base	18
3.2.2 Connect handle, headset (optional)	19
3.2.3 Connect power and network cable	19
3.3 Phone initialization	21
3.4 Phone standby interface	21
3.5 Check phone status	21
3.6 Set up phone network	22
3.7 Register an account	25
3.8 Phone input method	25
4. Phone customization	27
4.1 Basic setting	27
4.1.1 Language	27
4.1.2 Time & Date	28
4.1.3 Call out button	31
4.1.4 Keypad Lock	32

4.2 Voice setting	34
4.2.1 Volume setting	34
4.2.2 Ringtone setting	35
4.2.3 Key tone	36
4.2.4 Signal tone	36
4.3 Contact management	38
4.3.1 Local contact	38
4.3.2 Blacklist	45
4.3.3 LDAP configuration	47
4.4 CDR (call history) management	50
4.5 Accessories customization	51
4.5.1 Headset	52
4.5.2 Extension module	52
4.6 System customization	59
4.6.1 Account management	59
4.7 Programmable key	60
4.7.1 Account key	60
4.7.2 Account key function type description	61
4.7.3 Programmable function keys	62
4.7.4 Programmable function keys type description	63
4.8 Dial plan	64
4.8.1 Dial plan syntax	65
4.8.2 Dial plan function	65
5. Basic function	72
5.1 Make a call	72
5.2 Answer the call	74
5.3 End the call	74
5.4 Redial	74
5.5 DND	75
5.6 Call Forward	76
5.6.1 Active transfer	76
5.6.2 Auto transfer	76
5.7 Call Transfer	78
5.7.1 Blind Transfer	78
5.7.2 Inquiry transfer	80
5.8 Auto Answer	81
5.9 Anonymous Call	81
5.10 Hotline	82
5.11 QR code	83
5.12 Conference	83
5.13 Upgrade	85
5.14 Upload ringtone	85
6. Advanced Features	87
6.1 BLF (Busy Lamp Field)	87
6.1.1 Configure BLF button	87
6.1.3 Use BLF Function	88

6.2 Intercom	89
6.2.1 Set the intercom function button	89
6.2.2 Intercom function setting	89
6.2.3 Intercom function description	89
6.3 Multicast	90
6.3.1 Multicast configuration	90
6.3.2 Paging list configuration	91
6.3.3 Receive multicast RTP stream	93
6.3.4 Multicast use	94
6.4 Message	94
6.4.1 SMS	94
6.4.2 Voicemail	97
6.5 TR069	98
6.6 Configuration management	99
6.7 Auto Provision	100
6.7.1 Preparing steps	100
6.7.2 Automatic update operation steps:	101
6.8 SIP configuration	103
6.8.1 SIP Session Timer	103
6.8.2 Local SIP port and TLS SIP port	104
6.9 Action URL	105
6.9.1 The action that can realize reporting to the server	105
6.9.2 Variable description	108
6.9.3 Web page configuration description	108
6.10 Trusted Certificates	109

1. Outline

This chapter mainly provides a brief overview of the T790 IP phone. The main contents are as follows:

- [1.1 Hardware composition](#)
- [1.2 Display icon description](#)
- [1.3 Indicator description](#)
- [1.4 Configuration interface description](#)
- [1.5 Use documentation](#)

1.1 Hardware composition

The hardware components of the T790 phone mainly include a panel control panel, an LCD display, a handle and an external expansion disk. The details are as follows:

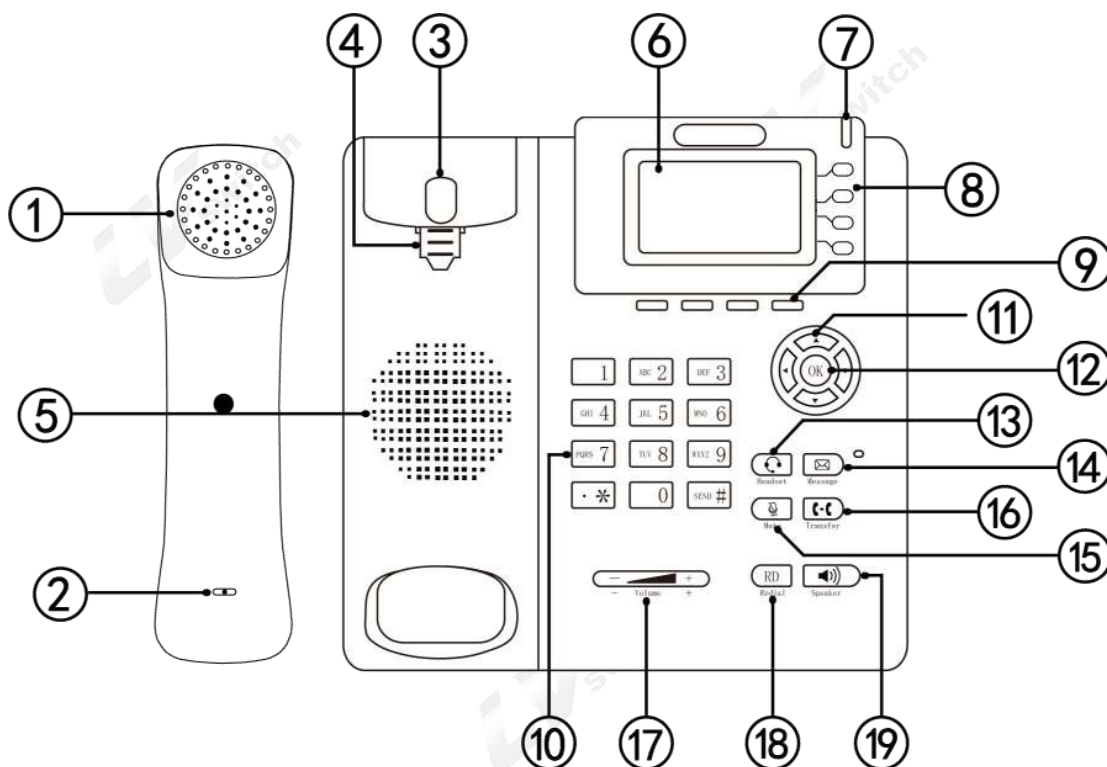

















Item	Name	Description
1	Handle handset	Audio output when using the handle to make a call
2	microphone	Audio input when using the handle to make a call
3	Hookswitch	Handle placed/hookswitch pressed——hang up Handle lift/hookswitch bounce——pick up Pak hook ——Flash operation

4	Handle hook	Used to fix the handle When the phone is wall-mounted, put the hook protruding position upward
5	Speaker	The phone outputs audio during a hands-free call
6	LCD	Display the information of the phone: -Register account information(Display name,display number) - Time and date - Reminder icon(For details, please refer to the display icon description) - Messages(Incoming call, missed call, email message) - Operation prompt
7	Breathing light	- Call reminder breathing light» Fast flashing - Message reminder breathing light» slow flashing For details, please refer to the indicator description
8	Account key	- shift the account - Intercom button - Caller ID call account light
9	4 soft keys(below the LCD)	Corresponding to the four function names at the bottom of the display(For example, there are 4 soft key functions displayed on the main interface: History,Dir,DND,Menu) These four soft keys will change with the operation of the phone keys. In the function description below, the soft keys refer to these four keys. The soft key functions correspond to the text at the bottom of the display screen.
10	Numeric keypad	Provide number input, uppercase and lowercase letter input, punctuation input(* # . :)
11	Up, down, left and right buttons	Options for switching
12	 button	- Function setting confirmation operation -Dial after entering the number - Answer the call - Check the network status(IP address、 MAC address、 version etc)
13	Headset Key(Headset)	Press the headset button to turn the audio to the headset, you must plug in the headset to use the headset mode.For details, please refer to the use of headset
14	SMS Key (Old SMS) (Message)	Configuration Voicemail feature code, this feature code is provided by IPPBX, after configuration, press the number to quickly query voicemail messages.
15	Mute KEY (Mute)	Press the mute button during a call to mute the call
16	Call transfer/transfer button (Transfer)	- Blind transfer - Inquiry transfer - Quickly switch call forwarding when the phone is idle

		It can also be achieved through the soft keys at the bottom of the screen
17	Volume up and down buttons 	Provide 0-15 levels volume setting
18	RD Button (Redial)	Used to redial
19	Speaker Button (Speaker)	Used for hands-free calling.

1.2 Display icon description

T790 display screen mainly used icons and their corresponding descriptions are as follows:

Type	ICON	Description
Account		Account is not activated/not registered
		Registering
		Registered
Voice status		DND
		Auto answer
		Missed calls
		Voice mail
		Test Message
		The mute mode
		Speaker phone mode
		Handset mode
		Headset mode
		Call mute
		Call forwarding enabled
Call list icon		Missed call
		Received call
		Dialed call

System icon		Network Unavailable
-------------	---	---------------------

1.3 Indicators Description

T790 indicator status and description are as follows:

Type	Indicator status	Description
Breathing light (Red light)	Off	Standby, power off
	On	The initialization indicator is always on when the phone starts
	Fast flash	The indicator light flashes quickly when the phone is ringing
	Slow flash	When the phone receives voice messages, missed calls, etc., the indicator light flashes slowly
Account line light (Green light)	Off	The account is idle.
	On	The account line is busy. The account line is calling
	Fast flash	The line flashes quickly when the phone is ringing

1.4 Configuration interface description

The T790 phone supports the following ways to configure the phone:

- [Phone LCD configuration](#)
- [Web interface configuration](#)
- [QR code configuration](#)

Quickly configure the phone, through the phone LCD screen and the phone keyboard panel, you can configure and use the phone functions. After checking the IP address of the phone, you can also enter the IP address of the phone in the browser to view all the functions of the phone, and configure it through the browser. If there is no computer around, you can use your smartphone to scan the QR code provided by the phone for configuration. The details are as follows:

1.4.1 Phone LCD Configuration

Enter the menu through the menu soft keys, you can configure basic settings (language, ringtones, etc.), and configure advanced settings (account, network, etc.), enter the advanced settings need to enter the administrator password, the initial administrator password of T790 is admin. At the same time, there are some basic functions in the menu. Please refer to the function configuration chapter for specific function settings.

1.4.2 Web interface configuration

- How to view the IP address (IPv4 or IPv6) of the phone:

It can be viewed in any of the following ways:

1. Press the  button.

Note IPv4 address:192.168.1.123
IPv6 address:2003:4998:c:e33::1004

2. Press the menu soft key -> enter the status option.

After obtaining the IP address of the phone, enter the IP address in the computer web browser, for example: IPv4 address input (192.168.1.123 or http://192.168.1.123), IPv6 address input ([2003:4998:c:e33::1004] Or http://[2003:4998:c:e33::1004]), Enter the phone login page and use the login account password to enter the main interface. The initial administrator account and password are admin. For specific function setting introduction, please see the [function configuration](#) chapter.

1.4.3 Mobile phone scan code configuration

Get the phone's QR code through the phone's QR code function. Before scanning, the smart phone needs to be connected to the WIFI of the same network as the phone before you can use the smart phone to scan the QR code to access the phone's management page. For detailed feature settings, please refer to the [function configuration](#) chapter .

For more help, please contact your network administrator.

The configurable functions of the three configuration ways are compared as follows:

Function items	Phone configuration	Web configuration	QR code configuration
Status			
├ IPv4			
├ IPv6		√	√
├ MAC address	√		
├ Version			
└ Account status			
Account			
├ User information	√		
├ Display name	√		
├ User name	√		
├ Register name	√		
└ Password	√	√	√
├ Server information			
├ Sip server 1	√		
├ Sip server 2	√		
├ Sip port number	√		
├ Re-registration time	×		

└ Proxy server	√		
└ NAT	√		
└ Codec setting	×		
└ DTMF setting	×		
Network setting			
└ IPv4/IPv6/IPv4&IPv6	√		
└ DHCP setting	√		
└ Static IP setting	√	√	√
└ Advanced network setting			
└ CDP	√		
└ SNMP	√		
└ STUN	×		
Features			
└ Call forward	√		
└ Call transfer	√		
└ Auto Answer	√		
└ Anonymous Rejection	√		
└ Anonymous Call	√	√	√
└ Hotline	√		
└ QR code	√		
└ Heartbeat service	×		
└ DND	√		
└ Conference	√		
Advanced Features			
└ BLF(Busy Lamp Field)	√		
└ Multicast Paging	√	√	√
└ Intercom	√		
└ Configuration management	×		
└ Auto Provision	√		
Customization			
└ Time&date	√		
└ Multi language	√		
└ Sound			
└ Button voice	√		
└ Ring tone	√		
└ Signal tone	√		
└ call out button	√	√	√
└ Dial plan	×		
└ DSS keys	√		
└ Keypad Lock	√		
└ Directory			
└ Local directory	√		
└ Blacklist	√		
└ Remote PhoneBook	×		
└ LDAP	×		

Note Scan code configuration and web page configuration are the same, the following only shows the web page icons.

1.5 Usage Documentation

The technical support manual provided by T790 is as follows:

Name	Description	Obtain	Language
T790 quick user manual	Includes easy installation and phone customization	With IP phone	Chinese/English
		Lvswitch company website download	
T790 User Guide for IP Phone	Detailed function introduction and use	Lvswitch company website download	Chinese/English

2. Notes for safe use

Please read the safety instructions carefully before installing and using the phone to ensure safe and convenient use of the phone!

- Please use the power adapter specified by the product (supplied with the package). If you need to use the power adapter provided by other manufacturers due to special circumstances, please confirm that the voltage and current of the provided adapter comply with the specifications of this product (see the connection of power supply and network cable for details), and it is recommended to use safety certified products, otherwise it may cause damage to the equipment or may even cause a fire or electric shock. Before using this product, please check whether the power cord is damaged. Do not use damaged power cords and abnormal conditions such as twisted, stretched, or bundled power cords to avoid fire and electric shock.
- Non-technical service personnel must not disassemble or repair the product by themselves. Improper installation or repair may cause electric shock, fire and other accidents. At the same time, the warranty service of your product will also be invalid. If you need technical support, please contact the agent or your network administrator .
- Keep the temperature and humidity of the product in line with the working requirements of the product. Make sure that the product is placed flat on the workbench, and check that the non-slip glue on the product base does not fall off and cause the phone to slide on the platform. Please keep away from electrical appliances with strong magnetic or electric fields, such as microwave ovens or refrigerators, when placing the equipment. Keep the equipment away from fire sources.
- Do not put metal objects such as pins and iron wires into vents or gaps. Otherwise, it may cause electric shock and other injury accidents caused by current passing through metal objects. If similar metal objects fall into the product, stop using it in time.
- This product contains small parts inside. When placing the device, keep it out of the reach of children to avoid accidentally swallowing small parts.
- If you need to clean the phone, please cut off the power, wipe with a dry cloth, and place it in a ventilated place to dry naturally after cleaning. The power adapter needs to be kept dry and clean, otherwise accidents may occur.

3. Getting started with the phone

This chapter introduces the basic operation of the SIP-T790 IP phone, including the following contents:

- [3.1 Packing list](#)
- [3.2 Phone installation](#)
- [3.3 Phone initialization](#)
- [3.4 Phone standby interface](#)
- [3.5 Check phone status](#)
- [3.6 Set up phone network](#)
- [3.7 Register an account](#)
- [3.8 Phone input method](#)

3.1 Packing list

SIP-T790 IP phone contains the following accessories:

Items	Quantity	Photo
T790 IP phone	×1	
T790 IP handset handle	×1	

<p>T790 IP phone stand</p>	<p>×1</p>	
<p>T790 Handset cord</p>	<p>×1</p>	
<p>Ethernet cable</p>	<p>×1</p>	

Power adaptor(5.5mm DC plug 5V =1A)	×1	
Quick user manual	×1	

Note Before installing the phone, please check the integrity of the accessories according to the packing list. If any accessories are missing, please contact your network administrator or seller.

3.2 Phone installation

If you have successfully installed the phone, please skip this section and browse the [phone initialization](#) section.

The installation steps are as following :

- [3.2.1 Install the base](#)
- [3.2.2 Connect handset, headset\(optional\)](#)
- [3.2.3 Connect power cable and network cable](#)

3.2.1 Install the base

There are two types of base installation:

- a) Desktop installation
- b) Wall-mounted installation

- Desktop installation

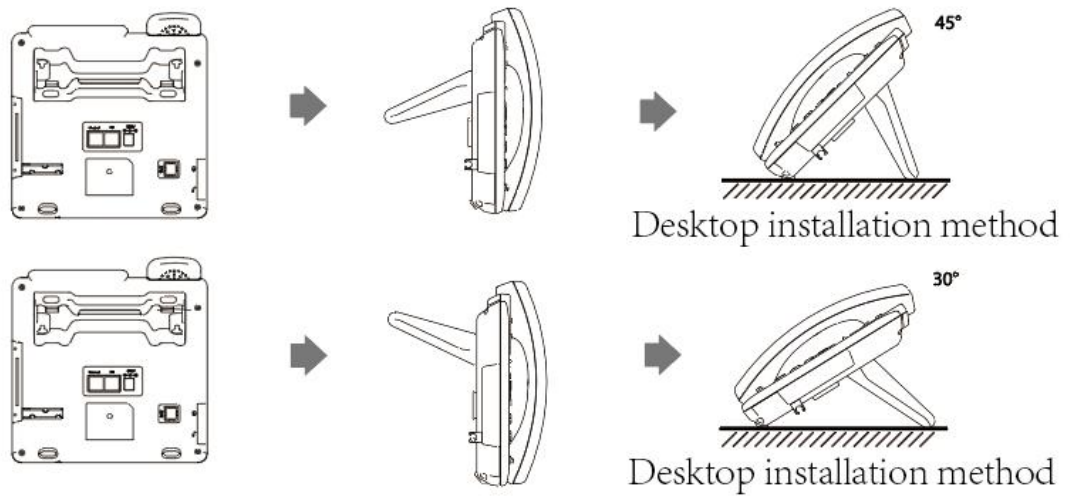

- Wall-mounted installation

When wall-mounted installation, it needs to reverse the handle hook to prevent the handle from falling off the phone.

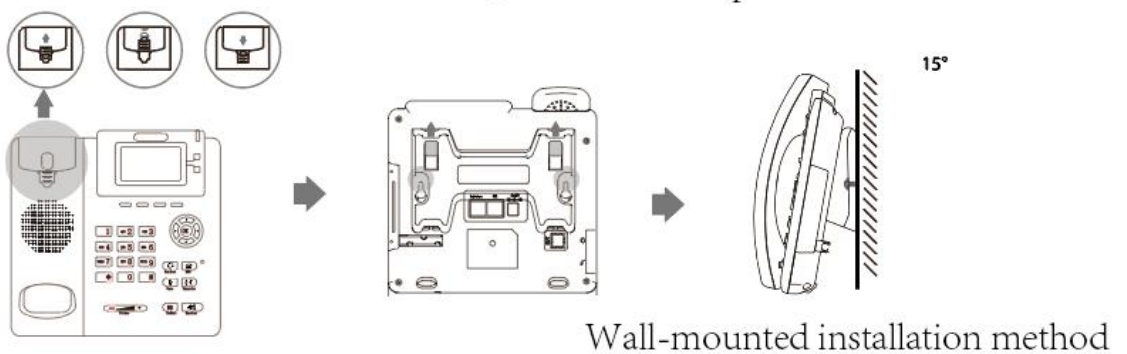

3.2.2 Connect handle, headset (optional)

A socket is a headset socket, and B socket is a handle socket.

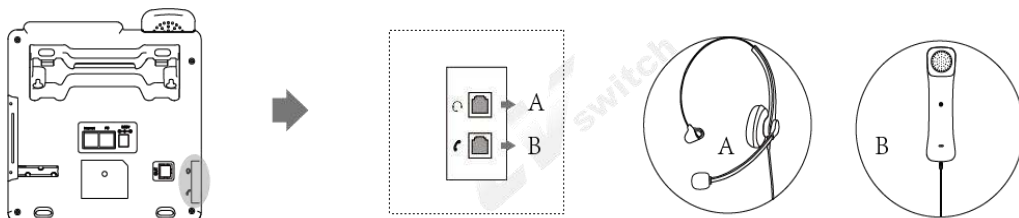

Note To use the headset, you need to turn on the headset mode. For detailed usage, please refer to the [headset usage](#) chapter.

3.2.3 Connect power and network cable

The phone supports two power supply methods:

- a) DC power
- b) POE

- DC power

Use the power adapter in the package to connect the power socket to the DC5V socket of the phone; use the Ethernet cable in the package or use a standard network cable to connect the upper switch/router to the Internet port on the back of the phone.

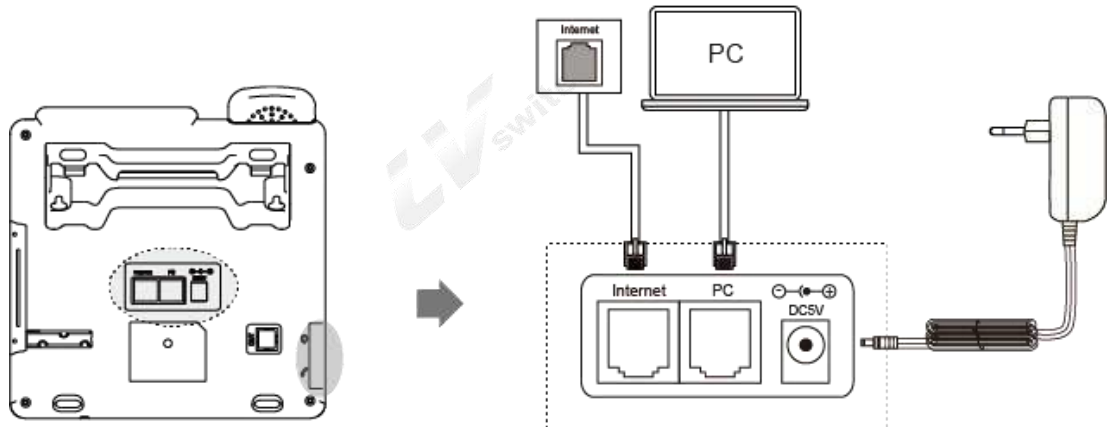

Note The voltage of the adapter used cannot be higher than 5V \approx 1A to avoid damage to the phone chip. For the safe use of the phone, please read the [safety instructions](#).

- POE power

Use an Ethernet cable to connect a switch or hub that supports PoE power supply to the Internet port on the back of the T790P ip phone.

IEEE802.3af standard POE switch

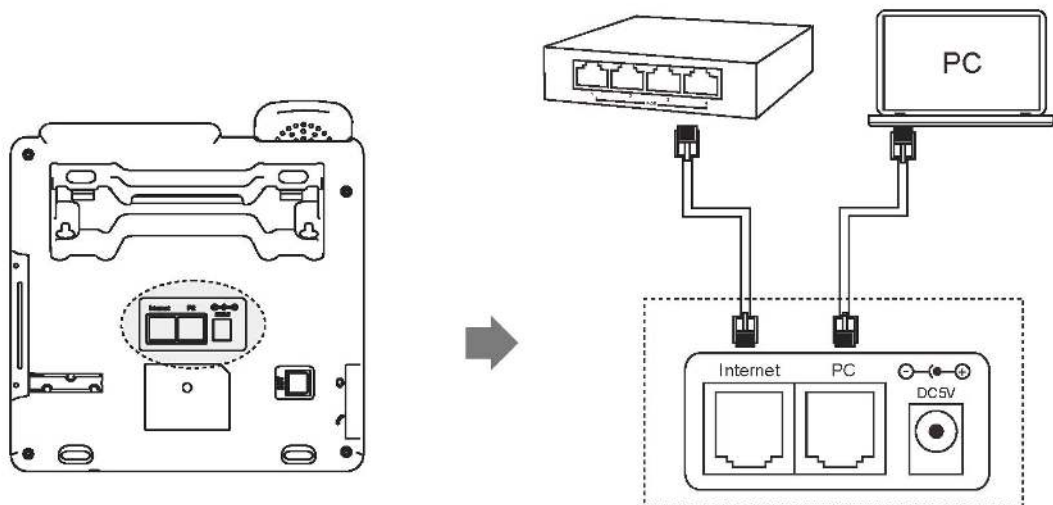

Note If you use POE power supply, please confirm whether your phone and switch support POE power supply. If you use POE power supply, you do not need to connect the adapter for power supply. If you need help, please contact your network administrator or dealer for confirmation.

3.3 Phone initialization

After the phone is correctly installed and powered on, the phone will start up and display the following display:

- Phone initialization
The red breathing light is always on and the two green account soft keys are always on, and the LCD screen displays “initializing”.
- Get network (the phone's initial network is automatically obtained by DHCP)
After the phone is successfully turned on, the phone will automatically obtain the assigned IP address, subnet mask, default gateway, DNS server and other network configuration. If the network cable is connected after the phone is turned on, the LCD screen will display the prompt of network acquisition.

Note If you cannot get the network information, please check the [network settings](#) chapter, or contact your network administrator or dealer to check.

3.4 Phone standby interface

The display interface after the phone starts normally is as follows:



The phone standby interface can display the phone's time, date, phone status (Do Not Disturb, Auto Answer), account registration status, extension number, label, and the labels of the four soft keys at the bottom of the LCD screen. Please refer to the [display icon composition](#) for the description of the icons on the standby interface.

3.5 Check phone status



The phone status contains the following information:

- Network information
IP mode、IPv4 / IPv6 address、subnet mask、default gateway、DNS server
- Account status
SIP account registration information

- Device information
Firmware version、 product name、 hardware version、 MAC address、 Product ID

You can check the phone status in the following ways:

- Phone interface

1. Press  button or press soft key **Menu->Status** to check .
3. Press  or  to select,Enter "**More...**" to view more detailed status.

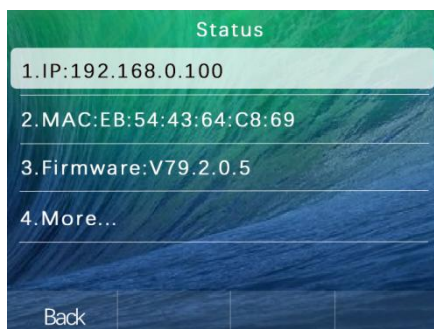

- Computer browser interface to view

1. Open the browser.
2. Enter the IP address of the phone (IPv4 /IPv6),192.168.0.103.
3. Enter the phone login page, enter the account and password to log in, the initial account and password is (admin/admin).

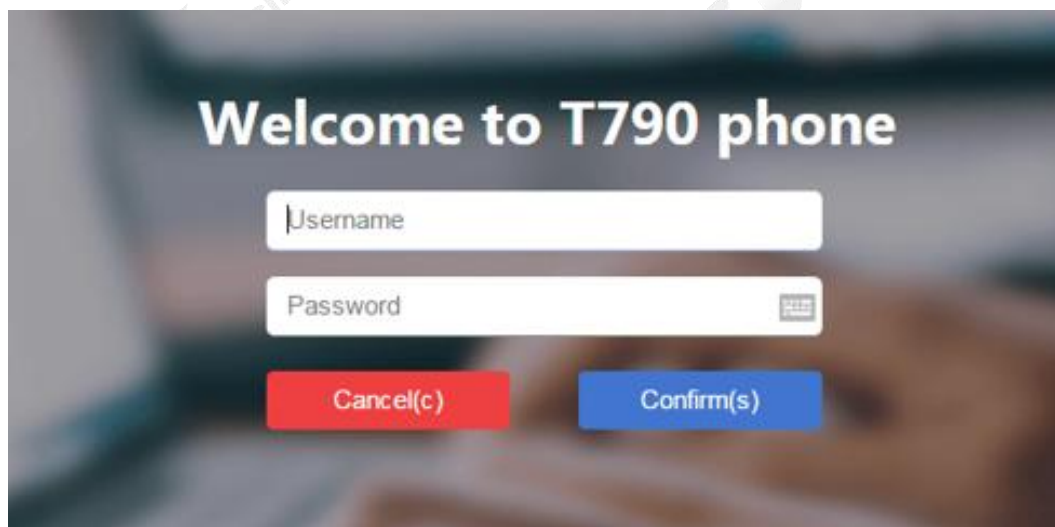

Note When entering an IPv6 address, you must add brackets before and after the address, such as [fe80::daec:a3ff:fe43:ad34], otherwise the phone webpage cannot be accessed through the IPv6 address, and not all servers support IPv6, please consult your Network administrator before use.



3.6 Set up phone network



T790 can set three network modes:IPv4、 IPv6、 IPv4 &IPv6.

Note If there is no need to configure the network mode, the default IP mode of T790 is IPv4, please skip this step.

- Set the network mode through the phone interface

1. Press **Menu** -> **Settings** -> **Advanced Settings (password: admin)** -> **Network** -> **WAN port**.

2. Press the **Switch** soft key or  and  to select the desired mode in the IP mode (IPv4、IPv6、IPv4 & IPv6).

3. If it is IPv4&IPv6 mode, you can configure the mode priority. Press  or  to select the mode priority, press the **Switch** soft key to switch. (IPv4 or IPv6).

4. After selecting the mode, press the **Save** soft key to save.

- Set network mode through web interface

1. Log in to the phone page by IP address.

2. Click **Network(N)**->**Basic(b)**->**WAN interface**, Select in the drop-down box.

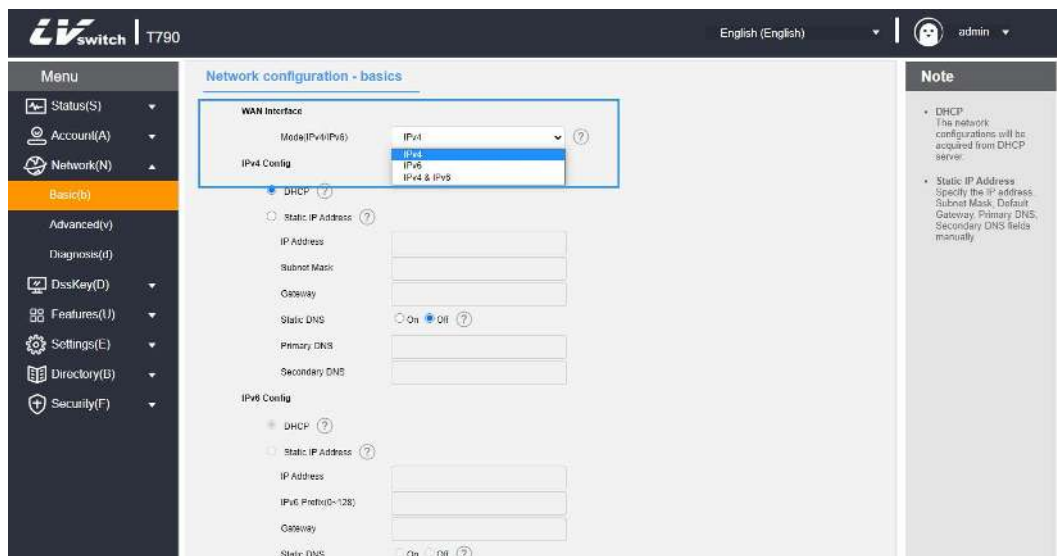

3. Click the **Confirm** button to save the configuration.





T790 phone can set static IP address.

- Set static IP via phone interface

1. Press **Menu** -> **Settings** -> **Advanced Settings (password: admin)** -> **Network** -> **WAN port**.

2. Press  or  select IPV4 or IPV6. Press the **Enter** soft key to enter the detailed settings.

3. Press  or  to select Static IPv4 client.

IPv4 needs to fill in the IP address, subnet mask, default gateway, primary DNS and secondary DNS.

IPv6 needs to fill in the IP address, IPv6 IP prefix, default gateway, primary DNS and secondary DNS.

- After filling in, press the **Save** soft key to save the configuration or the **Back** soft key to cancel the setting.

Static IPv4 Client	
1. Static IP:	192.168.0.100
2. Subnet Mask:	255.255.255.0
3. Default Gate...:	192.168.0.1
4. Pri. DNS:	114.114.114.114
5. Sec. DNS:	
<div style="display: flex; justify-content: space-around;"> Back 2aB Delete Save </div>	

- Set static IP via web browser

- Log in to the phone page by IP address.
- Click **Network(N)**->**Basic(b)**->**WAN interface** ,select **IPV4 or IPV6**.
- Fill in the static IP address according to the selected WAN interface mode:
 IPv4 needs to fill in the IP address, subnet mask, default gateway, primary DNS and secondary DNS.
 IPv6 needs to fill in the IP address, IPv6 prefix, default gateway, primary DNS and secondary DNS.
- Click the **Confirm** button to save the configuration.

Note Wrong IP configuration may cause the phone to fail to access the web interface. Please make sure that the IP address is not the same as the IP in the LAN before configuration. If you need help, please contact your network administrator.

3.7 Register an account

The T790 phone supports two configuration methods:

- Manual configuration
- Software batch configuration









The T790 IP phone supports dual account registration. The account switch is performed through the account button of the phone. The phone is generally configured by the system administrator. The account has been configured when the phone is obtained. You can use the account as long as you plug in the Internet cable to obtain the IP and the account is successfully registered. If the phone has not been configured with an account, you need to configure the account manually. For details, please refer to the [Account management](#) chapter.



3.8 Phone input method

The phone supports keyboard input, and you can use the numeric keyboard to enter data on the screen to configure the phone's functions.







T790 supports 4 input methods: 123 , 2aB, abc and ABC. When you need to input data, you can use the soft key to switch between these 4 input methods. When the input method is at 2aB, press the button repeatedly to switch the characters to be input (numbers/letters) /Punctuation), when you switch to the character you want, stop and wait for 1 second before entering the next character.

-The characters that can be input by different keyboard input methods are as follows:

Input method Button	123	2aB	abc	ABC
	1	1		
	2	2abcABC	abc2	ABC2
	3	3defDEF	def3	DEF3
	4	4ghiGHI	ghi4	GHI4
	5	5jklJKL	jkl5	JKL5
	6	6mnoMNO	mno6	MNO6
	7	7pqrsPQRS	pqrs7	PQRS7
	8	8tuvTUV	tuv8	TUV8
	9	9wxyzWXYZ	wxyz9	WXYZ9

	0	0	Space	Space
	*	*.'?!\\-()@/:	*.'?!\\-()@/:	*.'?!\\-()@/:
	#	#	#	#

- Input method introduction :

Example	Method
Input English word "Switch" Switch	- Switch input method to ABC 1. Press the button  continuously, Until S appears. - Switch input method to abc 2. Press the button  for one time , until w appears. 3. Press the button  continuously, until i appears. 4. Press the button  continuously, until t appears. 5. Press the button  continuously, until c appears. 6. Press the button  continuously, until h appears. Finally form the word
Input IP address 192.168.0.1	- Switch input method to 2aB 1. Input number. 2. Continuously press  until symbol '.' appears.

4. Phone customization

You can customize the phone according to your own usage habits, such as: language, time & date, ringtones, contacts, Dir, etc. This chapter will give a detailed introduction to the customized phone. The main contents are as follows:

- [4.1 Basic setting](#)
- [4.2 Voice setting](#)
- [4.3 Contact management](#)
- [4.4 CDR management](#)
- [4.5 Accessories customization](#)
- [4.6 System customization](#)

4.1 Basic setting



T790 basic settings include the following points:

- [Language](#)
- [Time and date](#)
- [Call out button](#)

4.1.1 Language

T790 supports multiple languages, the default language of phone initialization is English, the phone interface and web interface are integrated: after the phone changes language, the web page will be refreshed and the language will be updated synchronously with the phone; when the web interface changes language, you need to restart the phone.

- Set the language through the phone interface

1. Press **Menu->Settings->Basic Settings->Language**.
2. Press  or  to select the language required.
3. Press the **Save** soft key to save the language selected by the  as shown below.



Note When the language of the phone interface is changed, after the web interface is refreshed, the language will be synchronously changed to the language set on the phone (for example: English is set on the phone interface, the web interface is refreshed, and the language of the web interface is also changed to English).

- Set the language through the phone interface

1. Enter the phone IP address to enter into the web interface.
2. At the top right of the web interface, select the language from the drop-down box.

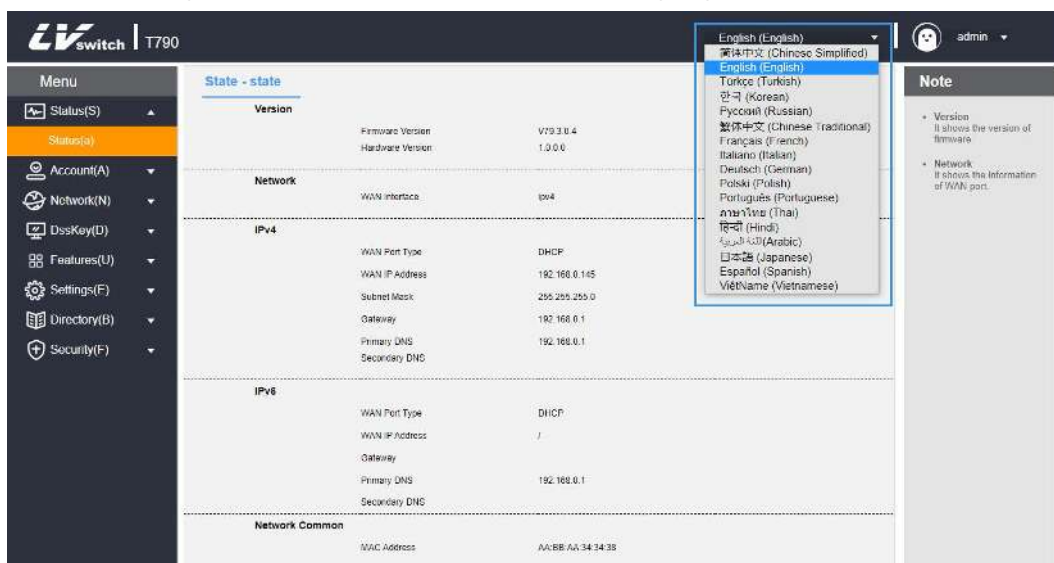

Note When the language of the web interface is changed, the LCD language will be synchronously changed after phone restart (for example: English is set on the web interface, then restart phone and the language of phone LCD is also changed to English).

4.1.2 Time & Date

T790 can be set to display the time on the LCD screen when the phone is in standby. Configure your SNTP server to automatically obtain the time and date, or you can manually set the time and date.

- Obtain the time and date automatically through the phone interface

1. Press **Menu** -> **Settings** -> **Basic Settings** -> **Time & Date** -> **Automatic Timing**.
2. Press the **OK** soft key to save.

- Set the time and date manually through the phone interface

1. Press **Menu** -> **Settings** -> **Basic Settings** -> **Time & Date** -> **Manual Timing**.
2. Press or to select.
3. Input the time and date you want to set through the numeric keyboard.
4. After setting, press the **Save** soft key to save.



Note The SNTP server cannot be configured on the phone interface. If you need to configure the time zone and SNTP server, please configure it on the web interface.

- Obtain time automatically via web browser

1. Log in to the phone page by IP address
2. Press **settings (E) -> date and time (t)**
3. Manual setting is disabled by default.
4. Primary server and secondary server fill in the SNTP server address.
5. Set the synchronization period, unit (seconds)
6. Click the **Confirm** button to save after setting

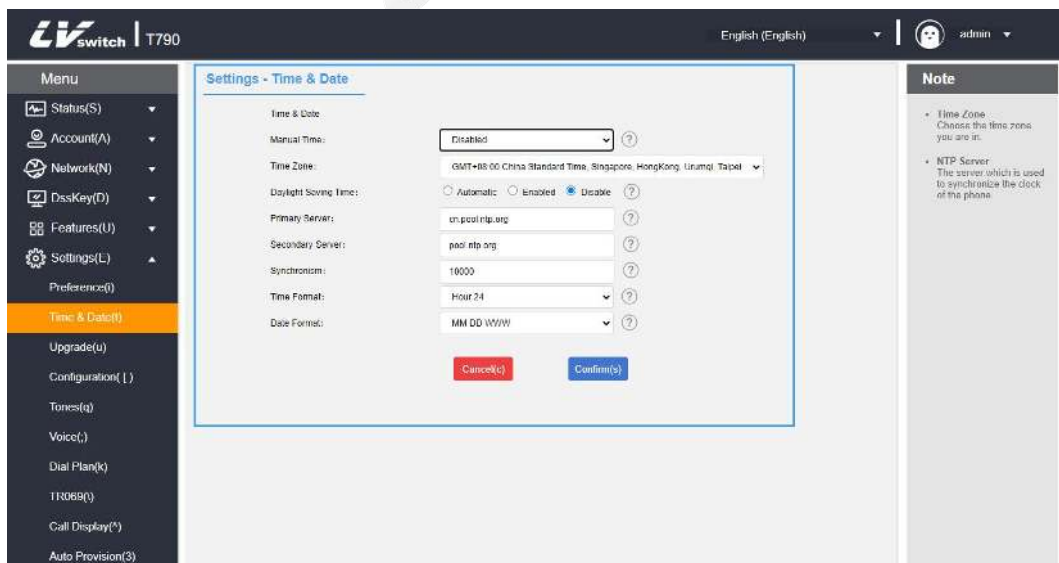

- Set the time manually via a web browser

1. Log in to the phone page by IP address
2. Press **settings (E) -> date and time (t)**
3. Manual setting is enabled.
4. Set the time and date as needed.
5. Click the **Confirm** button to save after setting.

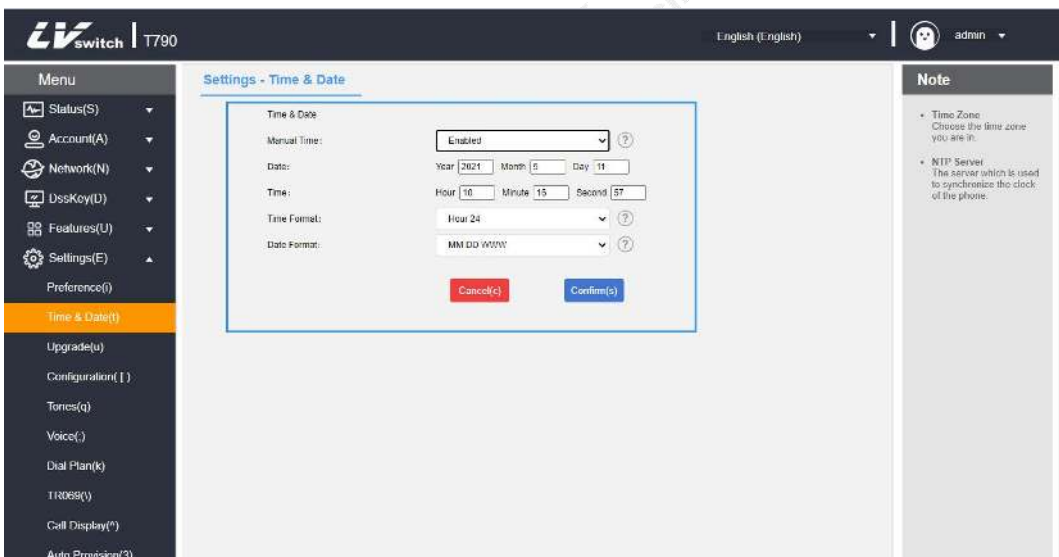

- Daylight Saving Time setting

1. Log in to the phone page by IP address.
2. Press **settings (E)** -> **date and time (t)**.
3. Daylight saving time is automatic, just select the corresponding location.
4. There are two types of manually setting the daylight saving time method by date or by week. Fill in the start time and end time.
5. Click the **Confirm** button to save after setting.

◆ Automatic set Daylight saving time:

The screenshot shows the 'Settings - Time & Date' configuration page. The 'Daylight Saving Time' is set to 'Automatic'. A dropdown menu for 'Place' is open, showing a list of locations including Australia (Perth), China (Beijing), Hong Kong, Urumqi, Kuala Lumpur, Russia (Yuzhik, Ulan-Ude), Singapore (Singapore), Taipei, and Uzbekistan. The 'Manual Time' is set to 'Disabled' and the 'Time Zone' is 'GMT+08:00 China Standard Time, Singapore, HongKong, Urumqi, Taipei'.

◆ Daylight saving time by date:

The screenshot shows the 'Settings - Time & Date' configuration page. The 'Daylight Saving Time' is set to 'Enabled'. The 'Fixed Type' is 'DST By Date'. The 'Start Date' is set to Month 3, Day 8, Hour 0, and the 'End Date' is set to Month 8, Day 29, Hour 12. The 'Manual Time' is set to 'Disabled' and the 'Time Zone' is 'GMT+08:00 China Standard Time, Singapore, HongKong, Urumqi, Taipei'.

◆ Daylight saving time by week:

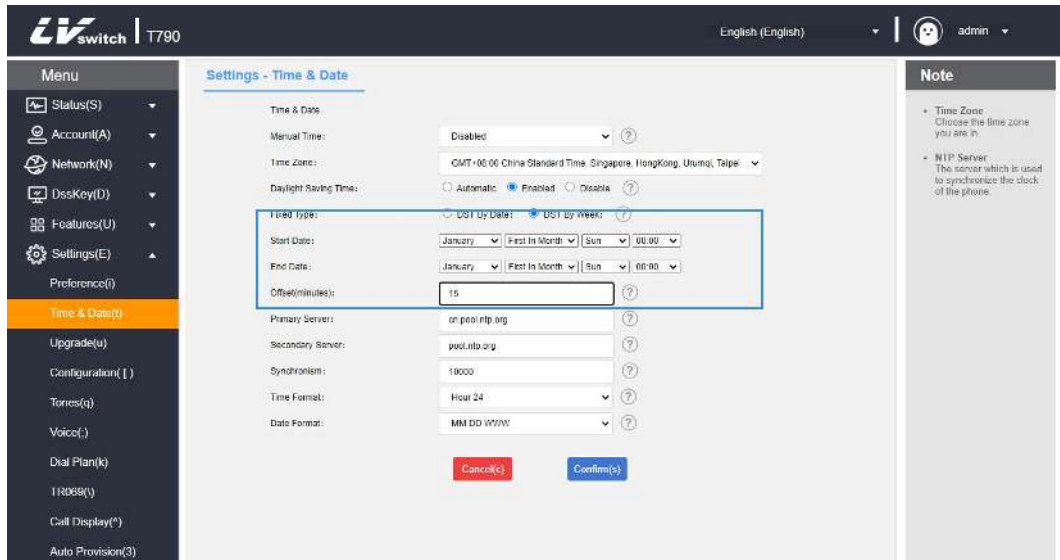

- Set time and date display format via web browser

1. Log in to the phone page by IP address.
2. Press settings (E) -> date and time (t).
3. Select the time format.(Hour 12 and Hour 24 format).
4. The phone supports 7 date formats, and different date formats will display the corresponding date on the phone LCD.

The following table shows the date displayed in each date format:

Date format	Display
MM DD WWW	Wed, Aug 12
YY MM DD	12-Aug-20
YYYY MM DD	2020-Aug-12
YYYY/MM/DD	12/Aug/2020
YY/MM/DD	12/Aug/20
YYYY MM DD	12 Aug.2020
MM DD WW	Wed 12, Aug

4.1.3 Call out button

T790 can set * and # numbers as the outgoing button, you can also use the  button, send soft key to make outgoing, set according to your personal habits.

- Set the outgoing key on the phone interface

1. Press **Menu->2.Features->4.Key as send**.
2. Use the switch soft key to switch the outgoing key(*、#、disable).
3. After switching, press the Save soft key to save the operation.

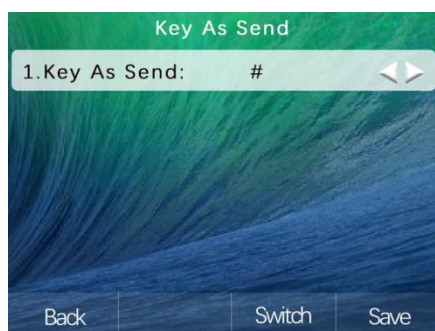

Note Please refer to the section on [making calls](#) for specific operations.



4.1.4 Keypad Lock

Enabling the keypad lock on the phone can prevent the phone from being used by unauthorized persons or accidental operations caused by accidental touches. When the keyboard is locked, only emergency call numbers can be dialed. If you need to dial other numbers, you need to unlock it.



Keyboard lock can be divided into types: Menu keys, Function keys and All keys

- **Menu keys:** Menu soft keys and programming keys are set as the menu keys are locked, other keys can be used.
- **Function keys:** The function keys such as the direction navigation key, OK key, Message key, Transfer key, Redial key, and 4 soft keys are locked. Other keys are used normally.
- **All keys:** Except for the * key, # key, numeric keyboard, hands-free key, account key, and volume adjustment key, all the other keys are locked. The dial interface can only dial preset emergency numbers. You can answer the call by lifting the handle, hands-free key, Headset key, answer soft key, and corresponding account key. You can reject the incoming call through the reject soft key.

- To set the keypad lock through the phone interface

1. Press **Menu->Settings->Basic Settings->Keyboard Lock**.
2. Enter the desired PIN (default PIN: admin) in the **Unlock PIN field**, and then press the **OK** soft key.
3. If you enter the default password, you will be prompted to change a new password. The password is using for to enter the phone keyboard lock setting and unlock the keyboard.
4. Press  or , or **Switch** soft key to select Enabled from the **Lock Enable field**.



5. Press  or , or **Switch** soft key to select keypad lock type from **Lock type field**.
6. Enter automatically locking time in **Auto Lock field** (0~ 3600 seconds)
 - A) If the time is set to 0 seconds, the keyboard lock will not be automatically locked after saving, you need to long press  to enable the keyboard lock.
 - B) If another time is set (for example, 10 seconds), the phone will automatically lock after the set time (for example, after 10 seconds) after standby.
7. Press **Save** soft key to save the change.

When the phone is locked, the LCD screen prompts “The keyboard is locked.”. And soft key showing will change to **Emerg**(emergency call) and **Unlock**(Use for unlock keyboard). As shown below:

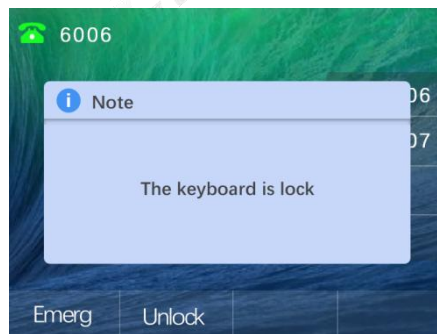

- To set the keypad lock through the web user interface

1. Log in to the phone page by IP address.
2. Press **Features (U) -> Keypad Lock (=)**.
3. Select **Enabled** from the Keypad Lock drop-down box.
4. Select **Lock type** from the Keypad Lock Type drop-down box.
5. If you need to change unlock password. Enter new password in Phone Unlock PIN field.
6. Enter automatically locking time in **Auto Lock field** (0~ 3600 seconds)
 - A) If the time is set to 0 seconds, the keyboard lock will not be automatically locked after saving, you need to long press  to enable the keyboard lock.
 - B) If another time is set (for example, 10 seconds), the phone will automatically lock after the set time (for example, after 10 seconds) after standby.
7. (Optional) You can set emergency call numbers, each number is separated by a comma.
8. Press **Confirm** button to save the change.

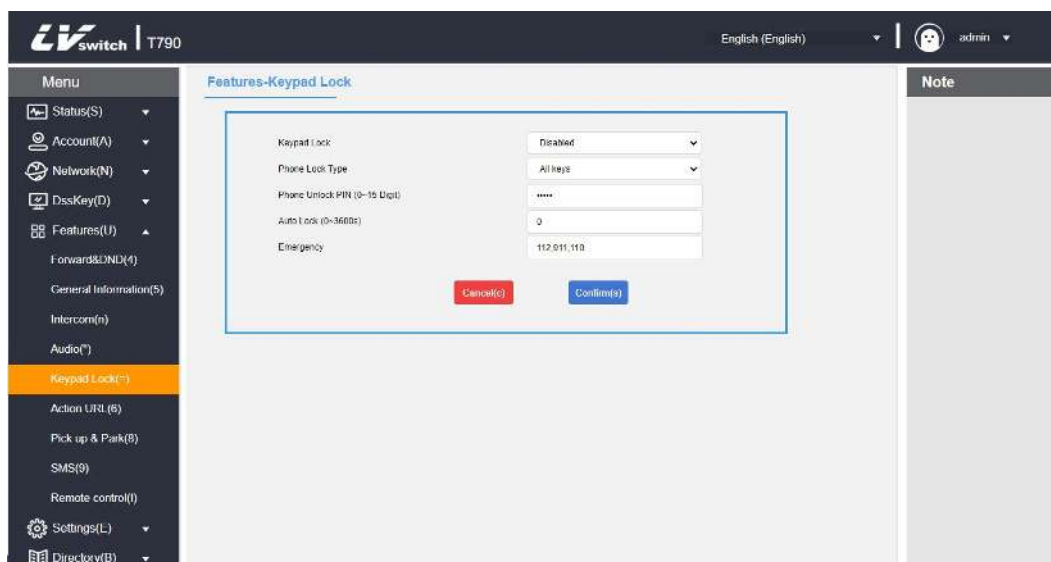

- To unlock keypad through the phone interface

1. Press the **Unlock** soft key or any locked key, such as menu key, function key, and all keys.
2. Enter unlock password in the Unlock PIN field.
3. Press **OK** soft key to unlock.

The **Unlock** soft key on the standby interface disappears, that is, it is successfully unlocked. Long press or wait for the unlocking time to lock the keyboard again.

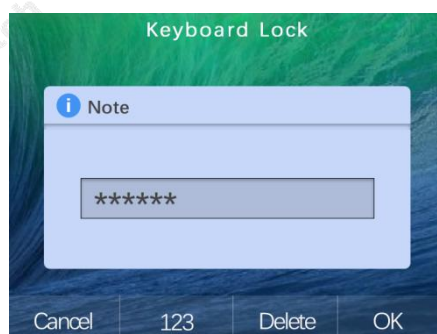

Note If you forget the unlock password, you can reset it via web user interface.

4.2 Voice setting

There are several sound settings in T790, including the following points:

- [Volume setting](#)
- [Ringtone setting](#)
- [Button voice setting](#)
- [Signal tones setting](#)

4.2.1 Volume setting

The T790 phone can set the ring volume and the volume during the call. The volume setting range is 1-15, and the volume becomes larger as the value increases.

- Set the ring volume of incoming calls in standby/ringing state

1. Press  to adjust the ring volume, as the diagram:



- Set the volume of the handset, speaker headset and other devices when a call comes in

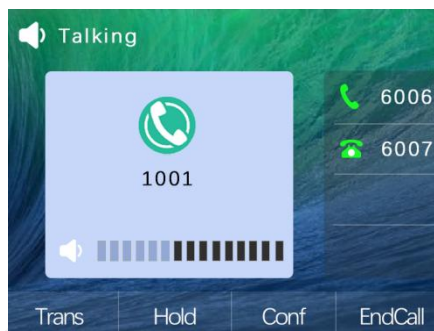

1. Press  adjust call volume, as the diagram shows:



4.2.2 Ringtone setting

You can set different ringtones for your phone to distinguish incoming calls. In addition to unified ringtones, contacts can also set different ringtones to distinguish incoming calls from different contacts. The system provides a total of 10 default ringtones to choose from.

- Set the ringtone for incoming calls on the phone interface

1. Press **Menu->settings->basic settings->sounds->ring tone**
2. Press  or  to select the ring tone.
3. Press the Save soft key to save the selected ringtone.



- Set the contact ringtone in the web browser

1. Log in phone web interface via IP address.
2. Directories(**B**)->**Address list(x)**.

3. Add a contact or click the contact in the list to edit.

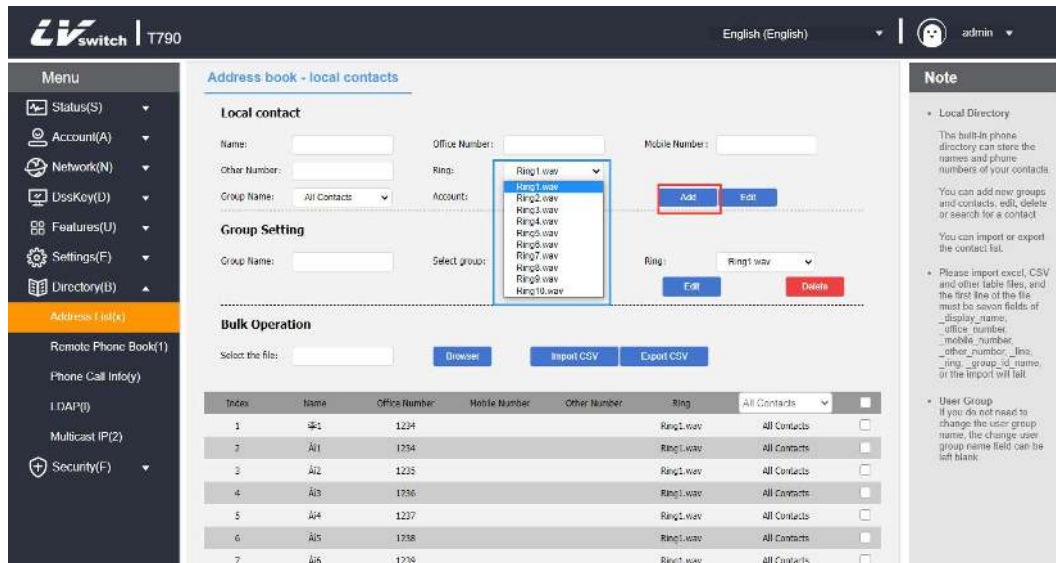

4. Click ringtone selection box to select the ringtone of the contact.

5. If you want to add a contact, click the add button, if you want to modify a contact, click the edit button.

4.2.3 Key tone

The phone will emit a key tone when pressing the keyboard key to indicate that the key has been triggered. The key tone can be enabled and disabled by setting.

- Set the phone key tone through the phone interface

1. Press **Menu->settings->basic settings->sounds->Key tone**.

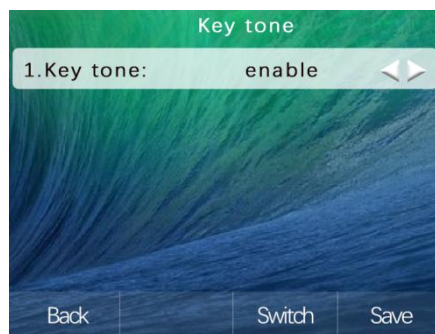

2. Press the switch soft key or and to enable and disable the key tone.

3. Press the **Save** soft key to save.

4.2.4 Signal tone

The audible signal sent by the switch to the user indicates that the phone is in a certain state. The signal tones follow a unified standard in each device. You can customize the signal tones according to national standards, or you can customize the signal tones. The lower the value, the lower the signal tone.

- Set signal tone via web browser

1. Log in to the phone page by IP address.
2. Press **Settings(E)->tones(q)**.
3. Please select the country according to the national standard. If you want to customize the signal tone, select custom in the country option.
4. To select custom, you need to fill in the value yourself to change the signal.
5. Click save button to save settings.

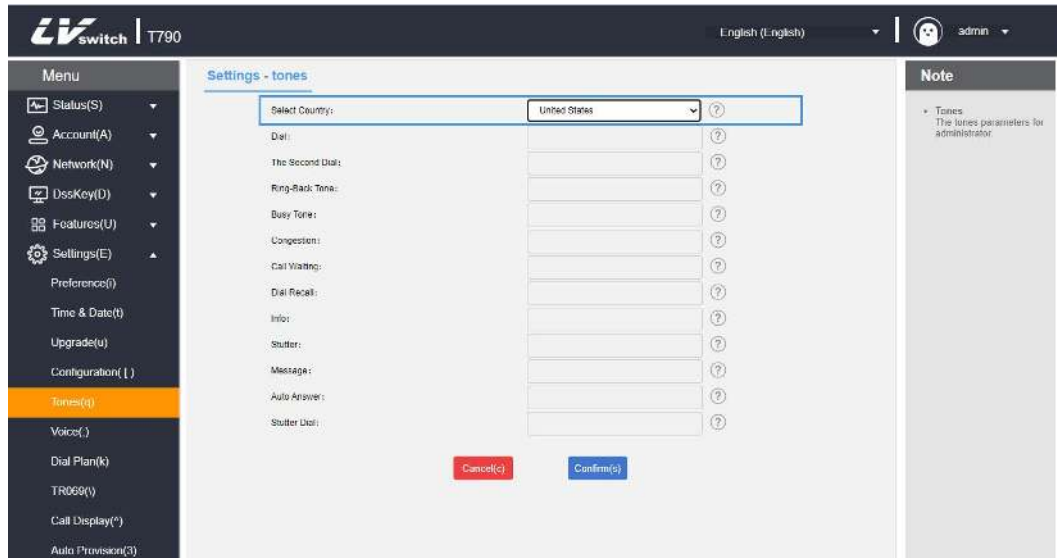

- Signal tone type introduction and standard

Signal tone	frequency	Transmission frequency(dBm0)	Description
Dial	450±25	- 10±3dBm0	Used to notify the calling user that they can dial
The Second Dial	450±25	- 10±3dBm0	Prompt tone during second dialing
Ring-Back Tone	450±25	- 10±3dBm0	Indicates that the called user is ringing
Busy Tone	450±25	- 10±3dBm0	Indicates that the connection is busy or the called party is busy
Congestion	450±25	- 10±3dBm0	Indicates that this connection has encountered machine line congestion
Call waiting	450±25	- 10±3dBm0	Indicates that the phone is in call waiting
Dial Recall	450±25	- 10±3dBm0	Indicates that the phone is in a callback state
Info	450±25	- 10±3dBm0	Beeps when receiving special information
Stutter	450±25	- 10±3dBm0	Prompt tone when receiving voice message

Message	450±25	- 10±3dBm0	Tones for receiving messages
Auto Answer	450±25	- 10±3dBm0	Prompt tone in automatic answering state
Stutter Dial	450±25	- 10±3dBm0	Prompt tone for voice mail callback

4.3 Contact management

Contact management of the T790 IP phone mainly includes:

- [Local contacts](#)
- [Blacklist](#)
- [LDAP](#)

4.3.1 Local contact

Local contacts can save the contact's name, internal extension number, mobile phone number and other information. T790 supports saving 1000 local contacts and 10 contact groups (including default groups). It supports operations such as adding groups, editing, setting ringtones, setting accounts, and editing contacts.

4.3.1.1 Add group

- Add group via phone

1. Press the soft key **Dir** -> **AddGrp**.
2. Fill in the group name.
3. Press the **Save** soft key to save the group.

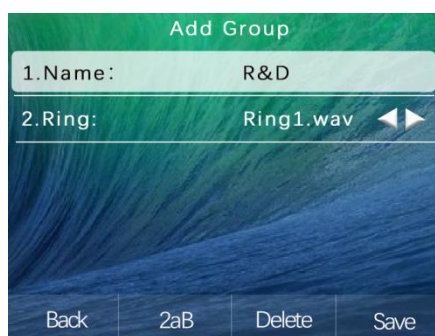

- Add group via web browser

1. Log in to the phone page by IP address.
2. Click **Directories(B)**->**Address list(x)**.
3. Enter the group name in the group name box.
4. Click the **Add** button to add a group.

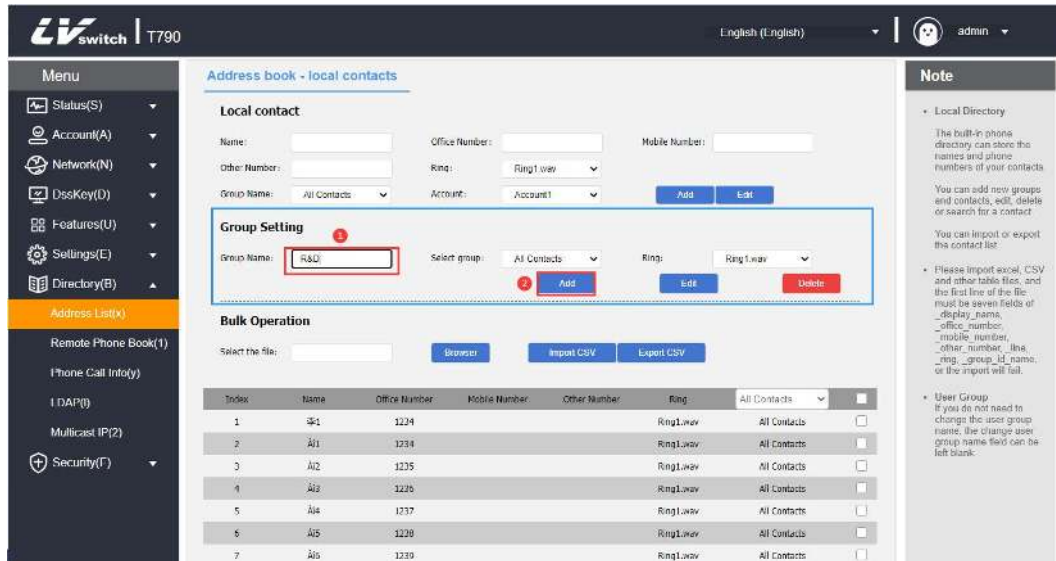

4.3.1.2 Edit group

- Edit group via phone (default group cannot be edited)

1. Press **DIR** soft key.
2. Press or to select the group name.
3. Press the soft key **Option** -> **Details** to enter the editing interface.
4. Enter the new group name in the group name edit box (only English can be input on the phone interface).
5. Press the **Save** soft key to save the group.



- Edit group name via web browser (default group cannot be edited)

1. Log in to the phone page by IP address.
2. Click **Directories(B)**->**Address list(x)**.
3. Select group.
4. After the selection, the selected group becomes an input mode, modify it to the name to be changed.
5. Click the **Edit** button to make changes.

The screenshot shows the 'Address book - local contacts' page. The 'Group Setting' section has 'Administration' selected in the 'Select group' dropdown. The 'Delete' button is highlighted with a red box and a '2' next to it. The 'Bulk Operation' section has 'Import CSV' and 'Export CSV' buttons. Below is a table of contacts:

Index	Name	Office Number	Mobile Number	Other Number	Ring	All Contacts
1	A1	1234			Ring1.wav	<input type="checkbox"/>
2	A11	1234			Ring1.wav	<input type="checkbox"/>
3	A2	1235			Ring1.wav	<input type="checkbox"/>
4	A21	1236			Ring1.wav	<input type="checkbox"/>
5	A4	1237			Ring1.wav	<input type="checkbox"/>
6	A5	1238			Ring1.wav	<input type="checkbox"/>
7	A6	1239			Ring1.wav	<input type="checkbox"/>

4.3.1.3 Delete group

- Delete group via phone (default group cannot be deleted)

1. Press **Dir** soft key.
 2. Press or to select the group needed to delete.
 3. Press **Option** soft key.
 4. Press or to select Delete option.
 5. Press **Delete** to delete the group.
- If you want to delete all contacts, press **Option->Delete All**.



- Delete group via web browser (default group cannot be deleted)

The screenshot shows the 'Address book - local contacts' page. The 'Group Setting' section has 'R&D' selected in the 'Select group' dropdown. The 'Delete' button is highlighted with a red box and a '2' next to it. The 'Bulk Operation' section has 'Import CSV' and 'Export CSV' buttons. Below is a table of contacts:

Index	Name	Office Number	Mobile Number	Other Number	Ring	All Contacts
1	A1	1234			Ring1.wav	<input type="checkbox"/>
2	A11	1234			Ring1.wav	<input type="checkbox"/>
3	A2	1235			Ring1.wav	<input type="checkbox"/>
4	A21	1236			Ring1.wav	<input type="checkbox"/>
5	A4	1237			Ring1.wav	<input type="checkbox"/>
6	A5	1238			Ring1.wav	<input type="checkbox"/>
7	A6	1239			Ring1.wav	<input type="checkbox"/>





1. Log in to the phone page by IP address.
2. Click **Directories(B)->Address list(x)**.
3. Select a group in the group module.
4. Click the button of the group setting module to delete.

4.3.1.4 Add contact

There are three ways of adding contact:



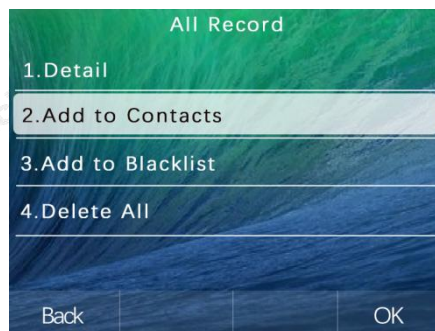

- Manually add
- Batch import
- Add from call record

- Add contacts via phone user interface

1. Press the **History** soft key in standby mode
2. Press  or  to select the number needed to add to contact.
3. Press soft key **Option-> Add** to contacts.
4. Press  or  to complete contact information (name, group, Mobile number, Office number, Other number, Ring, Account, etc.).
5. Press **Save** soft key to save the contact.



- Add contacts via local contacts on the phone interface

1. Press the **Dir** soft key on the standby interface (or press **Menu->Directory->Local Directory**)
2. Press  or  to select the group entering.
3. After entering the group, press the **Add** soft key to enter the add interface
4. Press  or  to fill in the contact information (Name, mobile number, office number, other number, ring, account, group, etc. Can switch to another group.)
5. Press the **Save** soft key to save the contact.



- Add contacts via web browser

1. Log in to the phone page by IP address
2. Click **Directories(B)->Address list(x)**
3. Fill in the contact information in the local contact module.
4. Click the **Add** button of the local contact module to add.

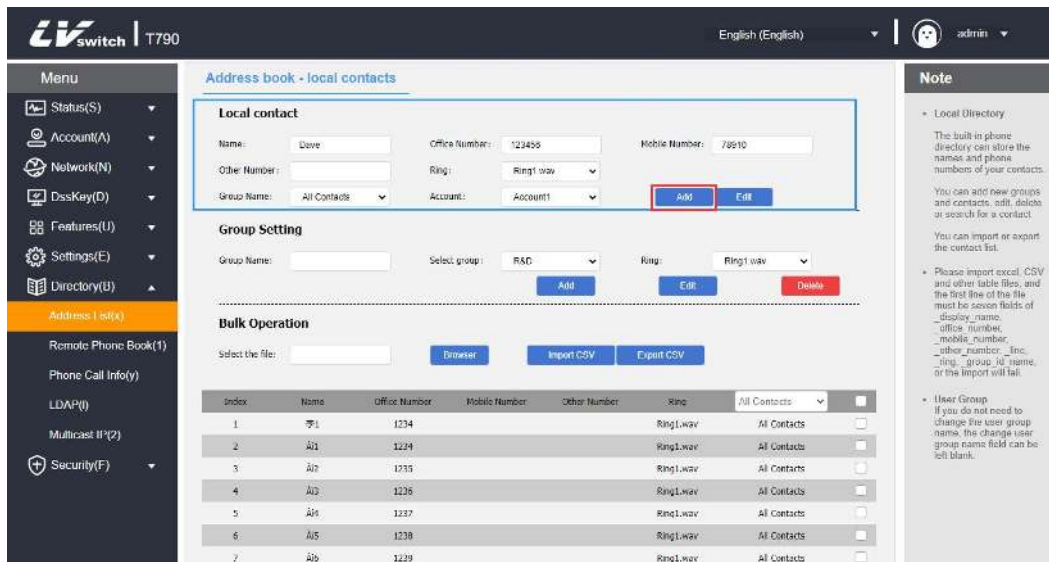

- Import contacts in bulk via web browser

1. Log in to the phone page by IP address.
2. Click **Directories(B)->Address list(x)**.
3. Batch operation module click on CSV format to export contact templates.
4. Add/edit contact information in the table
5. Batch operation module Click Browse to find the CSV file you want to import, click CSV format import to add contacts
(Currently only supports importing xls, csv, xlsx file types)

	A	B	C	D	E	F	G	H	I	J	K	L	M	N
1	_display_	_office_r_	_mobile_r_	_other_nu_	_line_	_ring_	_group_id_name							
2	Tony	1234				1 Ring1.wav	All Contacts							
3	Dave	1235				1 Ring1.wav	All Contacts							
4														
5														
6														
7														
8														
9														
10														
11														
12														
13														
14														
15														
16														
17														
18														
19														

After clicking Import, the following prompt will appear:

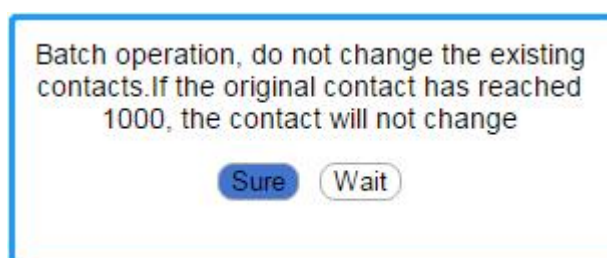

4.3.1.5 Edit contact

- Edit contacts via phone interface

1. Press the **Dir** soft key in standby mode (or **Menu -> Directory -> Local Directory -> All Contacts**).
2. Press or to select the person name needed to be edit.
3. Press soft key option-> details,enter into the edit page of the contact.
4. Press or to edit the contact information.
5. Press OK to save the editing operation



- Edit contacts via web browser

1. Log in to the phone page by IP address.
2. Click **Directories(B)->Address list(x)**.
3. Click the contact you want to edit in the contact list below, and the information will be filled in the local contact module.
4. Modify the contact information in the local contact module.
5. Click the **Edit** button to save the editing operation.

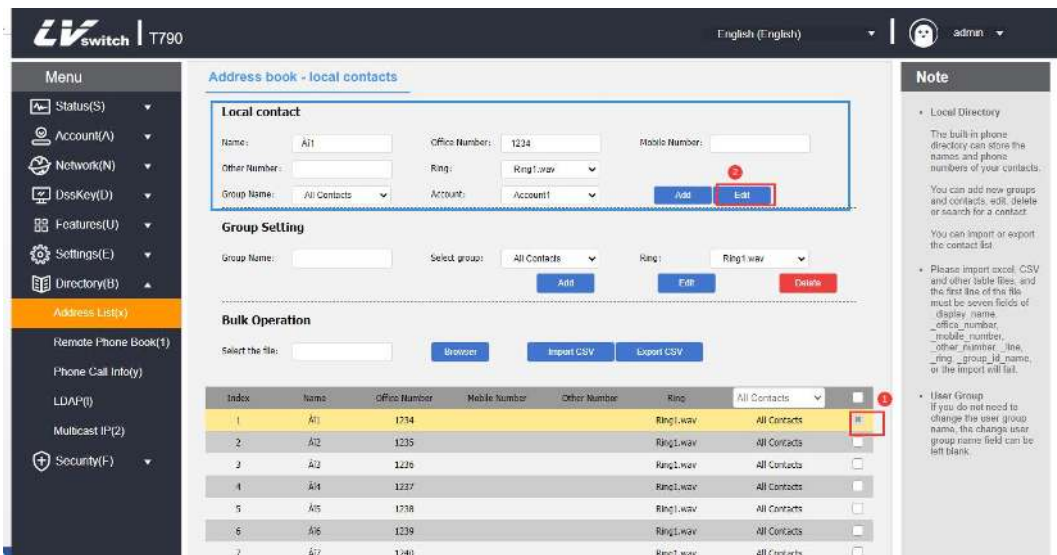

4.3.1.6 Delete contact

- Delete contact via phone user interface

1. Press the **Dir** soft key in standby mode (or **Menu -> Directory -> Local Directory -> All Contacts**).

2. Press or to select the name of the contact you want to delete.
3. Press **Option ->Delete/Delete all**.
4. Press the **OK** soft key to confirm the action.

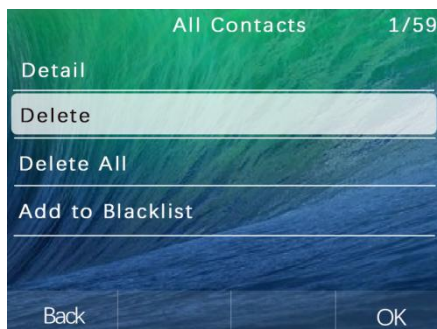

- Delete contacts via web browser

1. Log in to the phone page by IP address.
2. Click **Directories(B)->Address list(x)**.
3. Tap the contact you want to delete in the contact list below.
4. Click the **Delete/Delete all** button under the list to delete the contact.

Copyright ©2021 *Inc. All Rights Reserved

Note The deleted contact cannot be recovered. Confirm whether you want to delete it before deleting.

4.3.1.7 Call contact

- Call a local contact through the phone interface

1. Press the **Dir** soft key in standby mode (or **Menu -> Directory -> Local Directory ->All Contacts**).
2. Press or to select the name of the contact you want to call.
3. Press the **Send** soft key to enter the contact number list.
4. Press or to select the number you want to call to make a call. (mobile number or office number).
5. Press the **Send** soft key to make a call.





4.3.2 Blacklist

T790 can save up to 30 blacklisted contacts, and the phone numbers with blacklisted will be automatically rejected by the phone.



4.3.2.1 Add to blacklist

- Add a blacklist through the phone interface

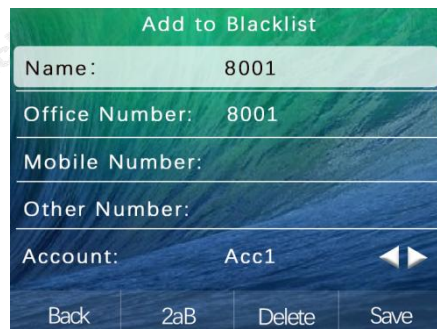
1. Press the soft key **Menu** in standby mode -> **Directory**-> **Local Directory** -> **Blacklist** -> **Add**.
2. Press  or  to edit blacklist information (name, mobile phone number, other number, account etc.).
3. Press the **Save** soft key to save changes to the blacklist members.



- Add a blacklist through the phone CDR interface

1. Press the **History** soft key in standby mode.
2. Press  or  to select the number added to the blacklist.
3. Press soft key **Option**->**Add to blacklist**.
4. Complete blacklist member information.
5. Press **OK** to save the blacklist.

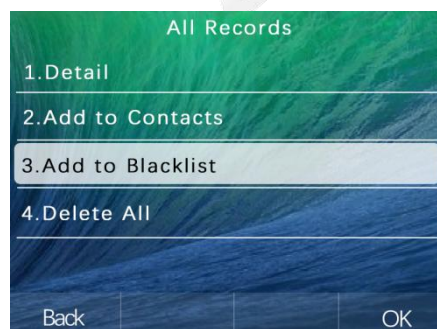

- Add blacklist via web browser

1. Log in to the phone page by IP address.
2. Click **Directories(B)**->**Address list(x)**.
3. Fill in the name and phone number to be added to the blacklist in the local contact module, and select the group as a Blacklist (BlackList).

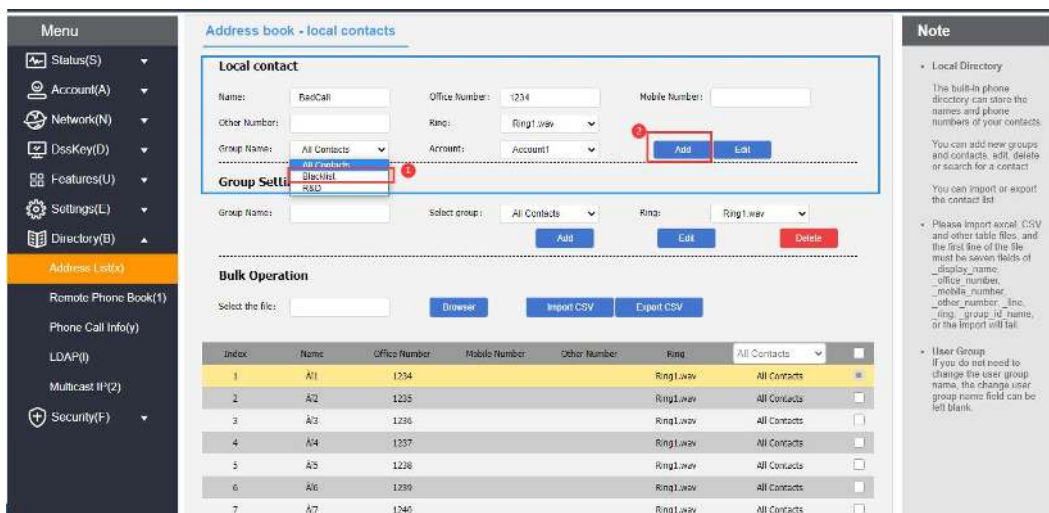

4. Click the **Add** button to save the blacklisted contacts.

4.3.2.2 Delete blacklist

- Delete the blacklist through the phone interface

1. In standby mode, press the soft key **Menu** -> **Directory** ->**Local Directory**-> **Blacklist**.
2. Press or to select the blacklist members to be deleted.
3. Press Option->**Delete/Delete all**.
4. Press the **OK** soft key to delete.

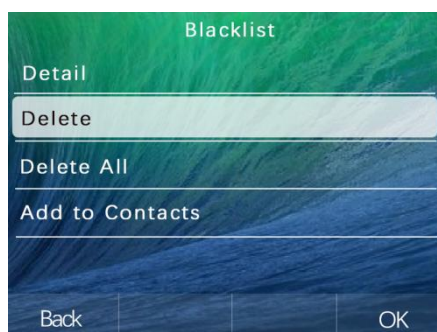

- Delete the blacklist through a web browser

1. Log in to the phone page by IP address.
2. Click **Directories(B)**->**Address list(x)**.
3. Select the blacklist from the drop-down box of the contact list below (BlackList) .
4. Check the blacklist to be deleted.
5. Click the **Delete/Delete All** button under the list to delete the blacklist.

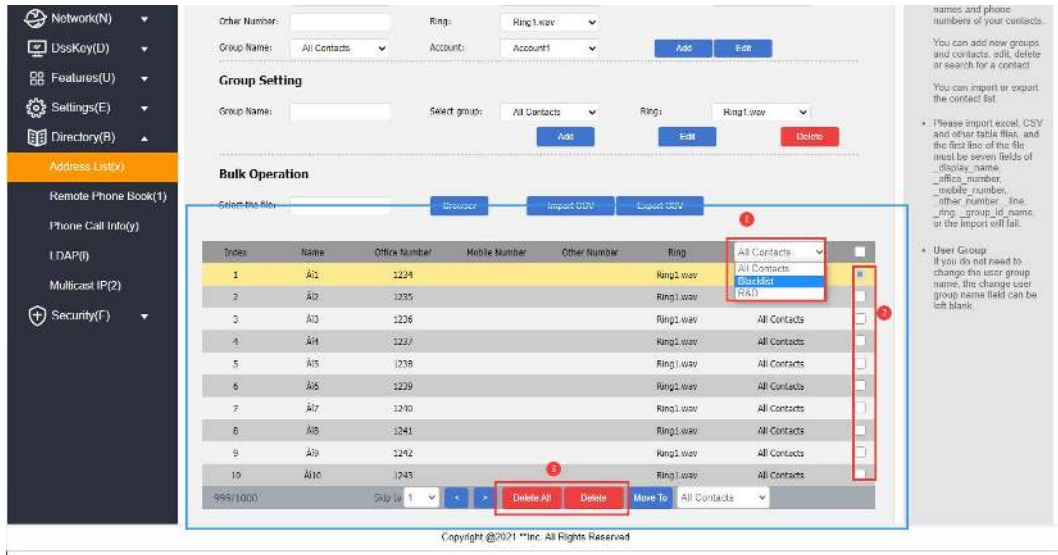

4.3.3 LDAP configuration

4.3.3.1 Function Description

LDAP (Light Directory Access Protocol, Lightweight Directory Access Protocol) is an application layer protocol running on an IP network that provides a series of functions for accessing and maintaining distributed directory information services. Simply put, LDAP is a fast way to get centralized static data about people or resources. LDAP is most useful for information stored in this way: data needs to be read from different locations, but does not need to be updated frequently. LDAP is very effective for storing the phone book and organization chart of company employees, and it is especially convenient for querying information.

For example: According to the tree structure, the root of the tree is the company name, and each department can be logically branched underneath, and each employee can be branched out under the department, and contacts can be retrieved within a certain range according to specific rules, such as the name of a company's hardware department. Including "J" employees, etc.

You can configure the phone to connect to an LDAP server that supports LDAPv2 or LDAPv3. The phone supports the following LDAP servers:

- Microsoft Active Directory
- Sun ONE Directory Server
- Open LDAP Directory Server
- Microsoft Active Directory Application Mode (ADAM)

The biggest advantage of LDAP is that users can quickly find contacts from the LDAP server, without the need to maintain a local phone book. The contact information returned by the LDAP server is read-only. Users can call LDAP contacts but cannot add, edit or delete LDAP contacts. The administrator can configure LDAP query filter conditions on the phone, such as the number of contacts displayed, the information returned, and how to sort contacts. How to perform LDAP search on the SIP-T790 series IP phone:

Directly enter the search content on the pre-dial/dial interface (make sure that LDAP is enabled for the outgoing contact matching list), and the phone will query from the LDAP server. If there is a result, it will be displayed on the LCD interface, and the user can select a contact and initiate a call.

Press the LDAP programmable button or press Menu->Contacts->LDAP, and enter the content to be searched in the LDAP search interface. The phone will query the relevant contacts from the LDAP server and display them on the LCD interface. The user can select one Contact and initiate a call, or add the contact to the local address book or blacklist.

The phone sends a search request to the LDAP server. The LDAP server searches for all contacts based on the entered search content and configured filter conditions, and then returns the matching results to the phone.

4.3.3.2 Configure LDAP server

The following example is for reference only. You can modify the LDAP attribute value according to your specific needs.

1. Open the web interface and login .
2. Click **Directories(B)->LDAP(I)**.
3. Configure LDAP parameters as following:

The screenshot shows the web interface for configuring LDAP. The 'LDAP' section is active, displaying the following settings:

- Enable LDAP: Enabled
- Label: LDAP
- LDAP Name Filter: CallerIDName=%
- LDAP Number Filter: AccountNumber=%
- LDAP TLS Mode: LDAP
- Server Address: 192.168.17.30
- Port: 389
- Base: dc=pbx,dc=com
- User Name: (empty)
- Password: (empty)
- Max.Hits(1~1000): 50
- LDAP Name Attributes: CallerIDName Email Departme
- LDAP Number Attributes: AccountNumber MobileNumbe
- LDAP Display Name: %FirstName
- Protocol: Version3
- LDAP Lookup For Incoming Call: Enabled
- LDAP Lookup for Callout: Enabled
- LDAP Sorting Results: Enabled

Buttons for 'Cancel(c)' and 'Confirm(s)' are visible at the bottom. A 'Note' section on the right explains that LDAP is an application protocol for accessing and maintaining information services for the distributed directory over an IP network.

4.3.3.3 LDAP setting explanation:

LDAP setting	Explanation	Example
Enable LDAP	Whether to enable the LDAP function or not	Enable
LDAP LABEL	Fill in the telephone directory name	Telephone Directory
LDAP name filtering	Set whether the phone can search for contact information by "nickname" or "last name". *Represents any letter. %Represents the input string and is used as	(CallerIDName=%)

	the prefix of the filter condition.	
LDAP number filtering	Set whether the phone can search for contact information by "mobile phone number, office number or home number". *Represents any letter. %Represents the input string and is used as the prefix of the filter condition.	(AccountNumber=%)
LDAP Encrypted transmission mode	Set the connection method between the LDAP server and the IP phone: ①LDAP ②LDAP TLS Start ③LDAPS	LDAP
LDAP server address	Fill in the IPPBX address	192.168.17.30
Port	Fill in the port of the LDAP server address.	389
Base	Fill in the root directory node of the LDAP server or a certain phone book node. The LDAP server will search for contacts from this node. ①Fill in the directory node of the LDAP server, the LDAP server will search for contacts from all the phone books. ②Fill in a phone book node, the LDAP server will search for contacts from this phone book.	dc=pbx,dc=com
User name	Fill in the user name of LDAP server	The user name provided by the LDAP server
Password	Fill in the password of the LDAP server	The password provided by the LDAP server
Max hit (1~1000)	Set the maximum entry of LDAP server search results.	50
LDAP Name Attributes:	Set the name attribute to be obtained. Multiple name attributes can be set, separated by spaces.	CallerIDName Email Department FirstName LastName
LDAP Number Attributes:	Set the attributes of the number to be obtained. Multiple number attributes can be set, separated by spaces.	AccountNumber MobileNumber HomeNumber Fax
LDAP Display Name	Set the display name of LDAP server search results. The display name format must start with %.	%FirstName
Protocol	LDAP server protocol version.	3
LDAP Lookup For	Set whether to perform LDAP search on	Enable



Incoming Call	incoming call numbers.	
LDAP Lookup for Callout	Set whether to search for numbers in the LDAP phone book when making a call.	Enable
LDAP Sorting Results	Set whether to sort the search results in alphabetical or numerical order.	Enable

4.3.3.4 Search LDAP contacts through the address book

- Enable LDAP address book

1. Log in the phone web interface, click **Directories(B)->LDAP**.
2. Enable LDAP address book.
3. Click **Confirm(s)**.

- Search LDAP contacts.

1. Click **Menu->Directory->LDAP**.
2. Input the name or number of the contact, the contact information that meets the search criteria will be displayed on the screen.
3. Press  or  to select the contact.
4. Press **Send** soft key, and make a call.

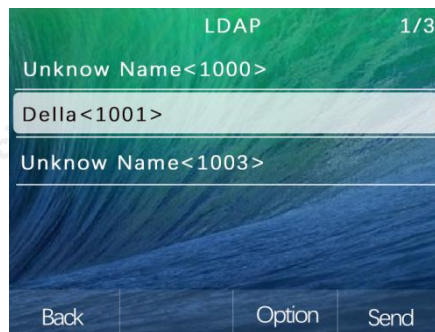



4.4 CDR (call history) management

The call history of T790 includes dialed numbers, missed calls, and received calls. Each record supports up to 300 records.

You can view, delete, add contacts, and add blacklists to the dialog list. For contact operations, please refer to the chapter on contact management.

- View the call history through the phone interface

1. Press the History soft key, the number list displayed on the LCD screen is the recent call record.
2. Press  or  to select the call record.
3. Press the soft key Option -> Detail. You can view the details of the record.



- View CDRs via web browser

1. Log in to the phone page by IP address.
2. Click **Directories(B)**->**Phone call info(y)**.

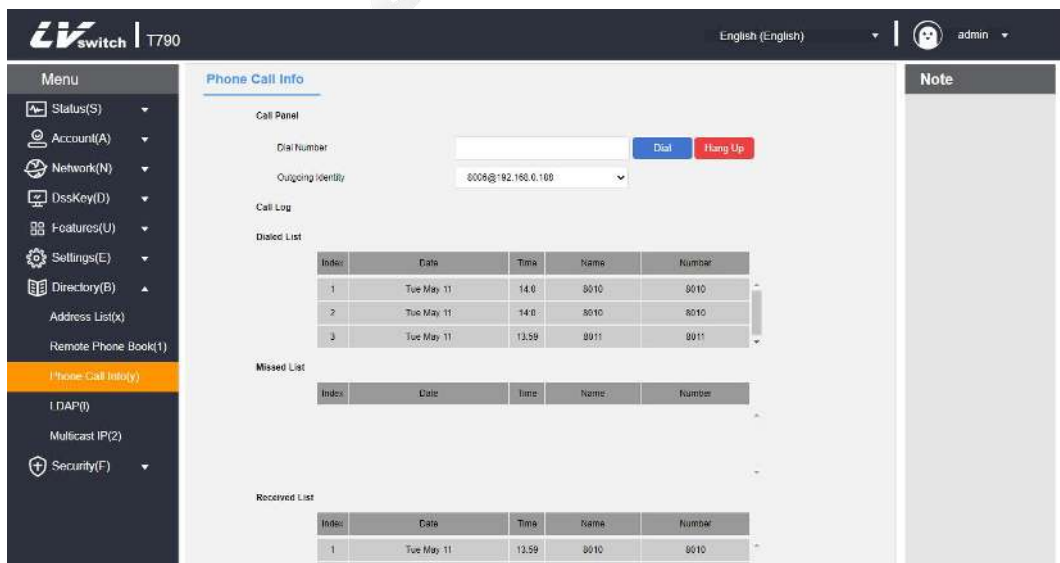

- Make a call from the CDRS

1. Press the **History** soft key when the phone is in standby.
2. Press or to select the number going to call.
3. Press **Send** soft key to make a call.



4.5 Accessories customization

T790 can be used with a variety of accessories, the main accessories are as follows:

- [Headset](#)
- [Extension module](#)

4.5.1 Headset

T790 can use a headset, you need to connect the headset before use, and use the function keys on the phone panel  (Headset) to activate headset mode. The installation of headset please check the chapter [phone installation](#).

- Activate headset mode

1. Press  (Headset) button on the phone panel.

The icon on the upper left corner of the LCD screen changes to a headset icon .

When the phone receives an incoming call, press the Answer soft key to answer the call, and the phone automatically enters the headset call mode.

Dial the number and press the send button, the phone will automatically use the headset mode to make a call.

- Quit the headset mode

1. Press the key on the phone panel  (Headset).

The icon in the upper left corner of the LCD screen changes to .

4.5.2 Extension module

The extension module greatly improves the function and scalability of the T790 phone. Each expansion station has 32 programmable buttons (two-color LED), which are connected to the IP phones that support the expansion station through an RJ-45 straight-through cable. T790K phones that support expansion interfaces can be connected to up to 6 expansion stations and provide 192 programmable keys. Combined with IP-PBX, each programmable key can realize speed dial, BLF, and cooperate with the server to realize functions such as call pickup.

The extension module is suitable for front desk switchboards, administrative assistants, call center agents, and users who need to monitor or manage a large number of calls.

4.5.2.1 Product information

Parameters	Explanation
Buttons	32 programable buttons,with red,yellow and green LED double LED lights
Panel jam	32 written mark
Button function	Fast dial,call transfer,call waiting,call pickup、BLF、 DND
Interface	One RJ45 data interface(IN),One RJ45 cascading interface (OUT), supports up to 6 expansion modules simultaneously.

Maintain	Maintain all data on the main phone web page
Power	No external power supply, powered by the phone network cable
Operating temperature	0~60 °C
Relative humidity	10%~90%
Size	174mm*100mm*35mm (Length*width*Height)
Weight	0.25KG

4.5.2.2 Expansion table packing list

Open the packing box of the extension station, carefully check the packing list, check whether the related accessories are complete, the packing list is as follows:

- One extension module
- One RJ45 network cable
- 1 metal mounting fastener (including 4 mounting screws)
- Expansion stand

4.5.2.3 Connect the expansion module

- Connect the phone with the extension station:

1. Connect the phone and extension station with metal mounting fasteners, and fix them with mounting screws.
2. Mounting brackets.
3. Use an RJ-45 network cable (straight-through cable) to connect one end to the IN port of the extension station and the other to the OUT port of the phone, as shown in the figure below:

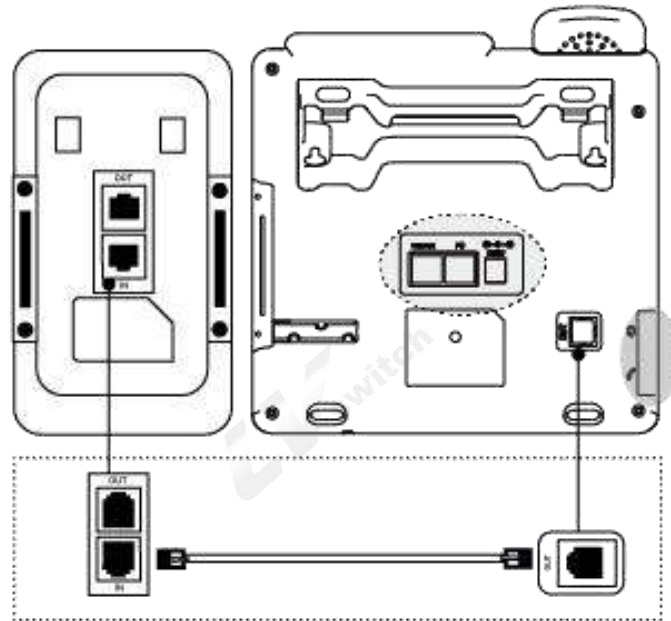

- Multiple expansion stations cascade:

1. Connect two or more expansion platforms with metal mounting fasteners, and install screws to fix them.
2. Mounting brackets.
3. Use RJ-45 network cable (straight-through cable), one end is connected to the OUT interface of expansion module A, and the other end is connected to the IN interface of expansion module B. As shown below:

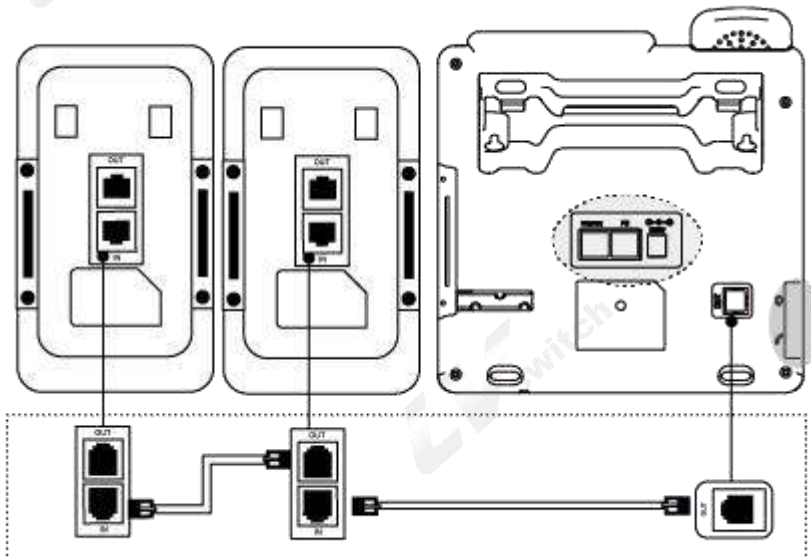

Note Up to 6 expansion modules can be connected.
After connecting the extension modules, you can set it through the phone's web management interface.

4.5.2.4 Expansion module hardware overview

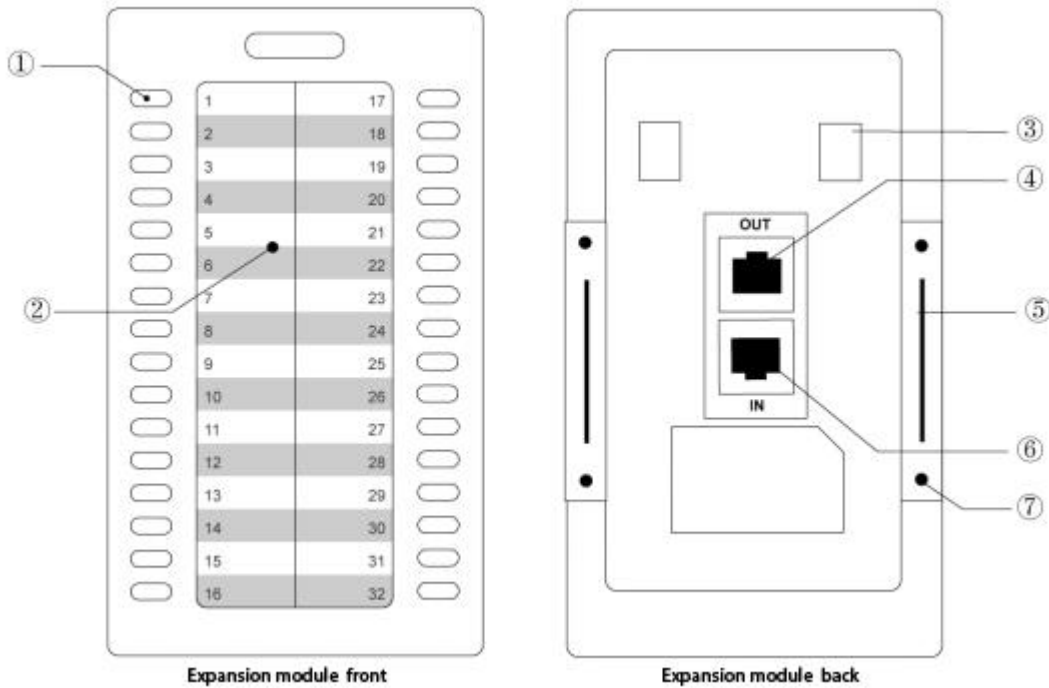

1

ITEM	Name	Description
1	Programmable buttons	<p>Can be used to bind speed dial numbers to realize speed dial;</p> <p>It can be used to set some function codes to cooperate with SIPServer to realize this function;</p> <p>After enabling BLF* (busy line detection), you can view the busy/idle status of the corresponding number:</p> <p>Steady red: the remote line is talking</p> <p>2)Flashing red: There is an incoming call on the remote line</p> <p>3)Steady yellow-green: The remote line is idle**</p> <p>The sequence of programmable keys:</p> <p>From top to bottom on the left: 1~16;</p> <p>From top to bottom on the right:17~32</p>
2	Paper jam in the expansion table	Provide the user with the identification definition of the speed dial number and the set function keys, which is convenient for users to refer to
3	Bracket slot	Used to fix the extension stand
4	OUT interface	Used when connecting to the IN port of the next expansion module
5	Metal fastener slot	Insertion position of metal fastener

6	IN interface	Used to connect the OUT interface of the phone or uplink expansion module OUT interface
7	Metal screw hole	Screw holes for installing metal fasteners

4.5.2.5 Testing expansion module

After the extension module is [correctly connected](#), you can check whether the buttons and LED lights of the extension module are normal through the phone diagnosis function. If you want to set the button functions of the extension module, please go to the web interface configuration. For details, see the extension module function description.

For each connected expansion module, you need to select the serial number of the expansion module for installation. Through this process, the phone can recognize the expansion module serial number corresponding to the connected expansion station. After successful installation, you can only check the status of the extension station in the phone status on the web page.

- Install expansion module

- Operate on the phone, click **Menu->Features->Expansion Disk Installation**, the screen displays "Press the number 1-6 of the extension disk to select the serial number, OK button to complete" (in general, the directly connected phone is the extension station 1, The next expansion station connected to expansion station 1 is expansion station 2, and so on, of course, you can also define by yourself);
- At this time, all the keys that can select the serial number on the expansion station will light up in yellow and green (from left to up and down 1~6 keys), the key corresponding to the current serial number of the expansion station will light up and flash in red, press the corresponding button, the button will light up and flash in red. Then you can determine or modify the serial number of the expansion station.
- Press  button or **Save** soft key to save.

Note

- The default serial number of the extension stand is 1. When there is only one extension stand, no installation operation is required.
- If the OK key or the OK soft key is not pressed within 35 seconds, the current serial number status of the expansion station will be automatically saved.

The rest of the selectable keys are all bright yellow, green, red and flashing. Press the corresponding key in the expansion station to modify the serial number of the current expansion station (assuming that the second button is now pressed). The current serial number is red and flashing. All the selectable keys will be lit. yellow-green

-Test expansion module

- Operate on the phone, click **Menu -> Settings -> Basic Settings -> Diagnosis -> Extension Disk -> Button**.
- The screen will display two lines of strings as shown below:



abcdefghijklmnop -----> Indicates the expansion disk 1-16 button
 qrstuvwxyz*#\$%@! -----> Indicates the expansion disk 17-32 button

Click the 32 buttons on the expansion disk in turn, and the characters on the screen will disappear accordingly. If you press a key and the character on the screen does not disappear, there is a problem with the key. If all the characters disappear, there is no problem with 32 keys.

Note 1.If you detect that the characters do not disappear when a button is pressed, please contact your network administrator or dealer for troubleshooting.
 2.When multiple expansion stations are connected, please repeat the above steps.

- Lamp diagnosis

1. Operate on the phone, click **Menu->Settings->Basic Settings->Diagnosis->Extension Disk->Light**
2. The screen display is as follows:

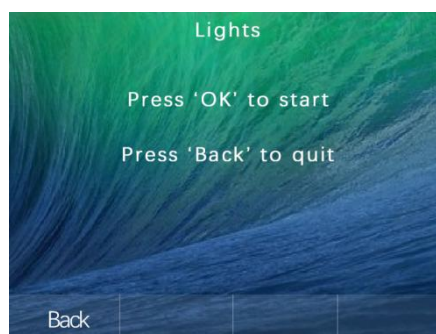

3. Press the **OK** button repeatedly, the LED lights of the expansion module will light up (when multiple expansion modules are cascaded, they will light up at the same time), red, yellow and green lights, observe whether the button LED lights are off, dim, and flashing when no operation is performed.

Note If there is any abnormal situation in the past, please contact your network administrator or dealer for troubleshooting.

4.5.2.6 Expansion disk function description

After installing the expansion disk (that is, after setting the serial number for the expansion station), you can set the buttons on the expansion disk. Here, you can bind the key to a remote extension number to realize speed dialing; or set it to some function code settings to cooperate with SIP Server to realize certain functions. Of course, you may also need to apply the BLF* function of the extension station button to view the call status of the corresponding remote extension.

- Web setting

The configuration and status can be made more simple and convenient through the setting of the web page. When setting the web page, the following points must be determined:

- (1) Connect the computer and the IP phone connected to the expansion station to the same network. If there is no network interconnection device, you can directly connect the computer to the PC port of the IP phone through a straight-through cable;
- (2) Ensure that the phone is running normally, check the IP address of the phone;
- (3) Enter the phone IP address in the address bar of the browser;
- (4) Enter the administrator user name and password and enter the web configuration page. The default administrator user name is admin and the default password is admin;
- (5) Click "**DSSKEY(D)**"> "**Ex Module**" in the left navigation bar to open the extended station settings page.

As the picture shows:

Key	Type	Account	Label	Value	Extension
Line Key1	BLF	Account1	123	6035	
Line Key2	BLF	Account1		6021	
Line Key3	BLF	Account1		6022	
Line Key4	BLF	Account1		6023	
Line Key5	BLF	Account1		6021	
Line Key6	BLF	Account1		6026	
Line Key7	BLF	Account1		6029	
Line Key8	BLF	Account1		6030	
Line Key9	BLF	Account1		6031	
Line Key10	BLF	Account1		6032	
Line Key11	BLF	Account1		6033	
Line Key12	BLF	Account1		6034	
Line Key13	BLF	Account1		6035	
Line Key14	BLF	Account1		6036	
Line Key15	BLF	Account1		6037	

-Set the expansion module

1. Select the expansion module n you need to configure.
2. Select the buttons you need to configure (for the specific button sequence, please refer to the Expansion Station Overview-Buttons and Hardware chapter).
3. Select each parameter, set and modify:

* **Type**: According to whether you need to use the BLF function, the button mode can be divided into two types:

- * **BLF**: Set the key to support BLF function and speed dial;
 - * **Speed dial**: set this key to support speed dial only.
 - * **Account**: Select the outgoing SIP account associated with this key, that is, which SIP account is used to call this number or function code.
 - * **Label**: Set the name description of the key.
 - * **Value**: Set the number for speed dialing of the key or the function code to realize a certain function of a certain server.
 - * **Extension**: For call pickup, fill in the pickup feature code + extension number. For the pickup feature code, please consult the server manufacturer's documentation.
4. Click the **Confirm** button to save.





4.6 System customization

4.6.1 Account management

T790 can register SIP accounts, up to 2 accounts, and make calls through the registered SIP accounts. Dual accounts can make multiple calls at the same time, and switch the account to use by pressing the account key.

4.6.1.1 Account Register

- Register an account through the phone interface

1. Press **Menu** -> **Settings** -> **Advanced Settings (password: admin)** -> **Account**.
2. Press  or  to select the account to be configured, and press the **Enter** soft key to enter the configuration interface.
3. The account status can be enabled or disabled by switch the soft key.
4. Press  or  to select display name, user name, registered name, password, SIP server 1 address, registered server port, SIP server 2, outbound proxy server, and NAT status etc.
5. Change the transmission mode by switching the soft key: UDP or TCP.
6. Press the **Save** soft key to save the account.

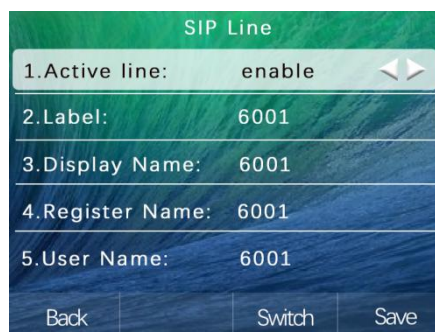

SIP Line	
1.Active line:	enable
2.Label:	6001
3.Display Name:	6001
4.Register Name:	6001
5.User Name:	6001
Back	Switch Save

Note If you need to register account 2, please repeat steps 2~6.

- Register an account through the web interface

1. Log in to the phone page by IP address .
2. Click Account(A)->Register(r).

3. Submit after filling in (required items: display name, user name, registered account, password, server address, port,transport protocol).

The screenshot shows the 'Account - registration' page in the LV switch T790 web interface. The page is divided into three main sections: a left-hand menu, a central form area, and a right-hand note section.

- Menu:** Includes Status(S), Account(A), Register(r) (highlighted), Codes(c), Advanced(i), Network(N), DssKey(D), Features(U), Settings(E), Directory(B), and Security(F).
- Account - registration form:**
 - Account: Account1
 - Register Status: Registered
 - Line Active: Enabled
 - Label: 8005
 - Display Name: 8006
 - Username: 8006
 - Register Account: 8006
 - Password: [masked]
 - SIP Server 1:**
 - Server Host: 192.168.0.188
 - Port: 54889
 - Transport: UDP
 - Server Retry Counts: 3
 - SIP Server 2:**
 - Server Host: [empty]
 - Port: 5060
 - Transport: UDP
 - Server Retry Counts: 3
 - Server Expires: 3600
- Note:**
 - Display Name: SIP service subscriber's name which will be used for Caller ID display.
 - Register Name: SIP service subscriber's ID used for authentication.
 - User Name: User account, provided by VoIP service provider.
 - NAI Traversal: Defines the STUN server will be active or not.

Note If there is a problem that the phone cannot be registered, please check whether the registered information is filled in correctly and whether the phone network is normal. If you need help, please contact your network administrator.





4.7 Programmable key

Divided into account keys, [extension disk keys](#) and programmable function keys.

4.7.1 Account key

The T790 phone has 2 account keys, located on the right side of the LCD screen. You can set different functions for these two buttons, and you can set the label of the account key. The label will be displayed on the location of the key on the LCD screen when the phone is in standby.

- Set the account key function through the phone interface

1. Press **Menu** -> **Features** -> **Dess keys** .
2. Press  or  to select which account key to edit..
3. Press the **Switch** soft key in the type selection to change the type.
4. Press  or  to select fill in the label and the user name etc.
5. Press **Save** soft key to save.



- Set account key function via web interface

1. Log in to the phone page by IP address.
2. Click the **DssKey (D) -> Line Key (w)**.
3. Select the account/intercom function in the type selection.
4. When set to intercom function, the value fills in the feature code+called number, and the filled label will be displayed on the right side of the LCD screen during standby.
5. After selecting, press the **Confirm** button to save.

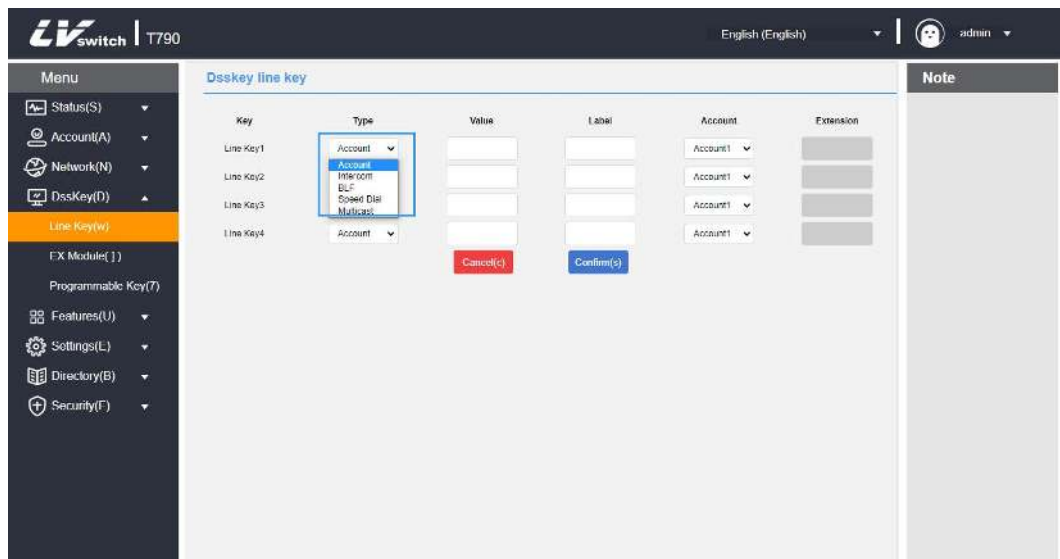

4.7.2 Account key function type description

	Type	Description and usage
Line key	Account	<p>The default setting is account key.</p> <p>- Use method:</p> <ol style="list-style-type: none"> 1. The line key type is set to account. 2. Value no need to fill. 3. Fill in the label as required. 4. Click the account key, the green light of the key is always on, a dial tone is issued, and the user is prompted to dial.
	Intercom	<p>The intercom function requires server support. You can directly contact the server manufacturer for consultation or check</p>

		<p>whether there is an intercom feature code through the server feature code to determine whether the function is supported;</p> <p>- Use method:</p> <ol style="list-style-type: none"> 1. Account key type is set to intercom. 2. Fill in the number "Intercom feature code + called extension number" 3. Set labels on demand 4. Click the account key, the green light of the key is always on, and it will automatically dial to the set number 5. Confirm that the intercom function is enabled on the web interface. 6. The phone of the called number automatically answers the intercom call. <p>For details, please refer to the detailed description of the intercom function.</p>
--	--	---

4.7.3 Programmable function keys

You can customize the soft key, navigation keys and function keys according to your personal habits.

- To customize programmable function keys via web user interface

1. Log in to the phone page by IP address.
2. Click the **DssKey (D) ->Programmable Key (7)**.
3. You can set Label for **SoftKey1 ~ SoftKey4**. The Label's value will show in LCD screen.
4. To customize your personal keys.
5. Press **Confirm** button to save change.

Key	Type	Account	Value	Label	Extension
SoftKey 1	History	Local History			
SoftKey 2	Directory	N/A			
SoftKey 3	DND	N/A			
SoftKey 4	Menu	N/A			
Up	History	Local History			
Down	Directory	N/A			
Left	Switch Account	N/A			
Right	Switch Account	N/A			
OK	Status	N/A			
Cancel	N/A	N/A			
TRAN	Forward	N/A			
Redial	N/A	N/A			
Message	N/A	N/A			

Note
 • Key Type
 The free function key Types Speed Dial, Key Event, Intercom.
 Key Event
 Key events are predefined shortcuts to phone and call functions.
 Intercom
 Enable the "Intercom" mode and it is useful in an office environment as a quick access to connect to the operator or the secretary.

Note If your programmable function have issues. You can press **Reset to default** button to restore factory setting.

4.7.4 Programmable function keys type description

	Type	Description and usage
Programmable key	N/A	/
	Group pickup	<p>After setting up group pickup, the number in the same pickup group can be picked up</p> <p>- Usage method:</p> <ol style="list-style-type: none"> 1. The type sets to group pickup. 2. The account is set to the corresponding account that needs to realize group pickup. 3. The value fills in Group Pickup Feature Code. 4. Set the label according to needs. 5. When there is incoming call in the accounts of pickup group, press the pickup key can realize group pickup.
	Intercom	<p>After setting up the intercom, pressing the account key will automatically dial to the set number to realize intercom</p> <p>- Using method</p> <ol style="list-style-type: none"> 1. The type sets to "intercom". 2. The account is set to the corresponding account that needs to realize intercom. 3. The value range is set to the intercom prefix + the number of the other party to be intercom. 4. Set the label according to needs. 5. Click the account key, the green light of the key is always on, and it will automatically dial to the set number. 6. The called number auto answers the intercom call. <p>For detailed please refer to the Advanced features-intercom.</p>
	History	<p>After setting the call history, you can directly enter the call record page.</p> <p>- Use method:</p> <ol style="list-style-type: none"> 1. The type is set to :History 2. The default is local history 3. Set the label according to needs. 4. After pressing this key, it enters into call history directly.
	Menu	<p>- Use method:</p> <ol style="list-style-type: none"> 1. The type is set to "menu"

		<ol style="list-style-type: none"> 2. Set the label according to needs. 3. After pressing this key, it enters into menu page.
	Forward	<ul style="list-style-type: none"> - Use method: <ol style="list-style-type: none"> 1. The type is set to “Forward”. 2. Set the label according to needs. 3. Press this key for the first time to enter the page of setting unconditional forward number, after setting it is unconditional forward switch.
	DND	<ul style="list-style-type: none"> - Use method: <ol style="list-style-type: none"> 1. The type is set to “DND”. 2. Set the label according to needs. 3. After setting, it is DND switch.
	Dial recall	<ul style="list-style-type: none"> - Use method: <ol style="list-style-type: none"> 1. The type is set to “dial recall”. 2. Set the label according to needs. After setting, it is dial recall button.
	Status	<ul style="list-style-type: none"> - Use method: <ol style="list-style-type: none"> 1. The type is set to “status”. 2. Set the label according to needs. 3. After setting, pressing can check the phone status.
	Local phonebook	<ul style="list-style-type: none"> - Use method: <ol style="list-style-type: none"> 1. The type is set to “Local phone book” 2. Set the label according to needs. After setting, press to enter local contacts.
	Switch account up	<ul style="list-style-type: none"> - Use method: <ol style="list-style-type: none"> 1. The type is set to “Switch account up” 2. Set the label according to needs. After setting, pressing the button is to switch up the default account.
	Switch account down	<ul style="list-style-type: none"> - Use method: <ol style="list-style-type: none"> 1. The type is set to “Switch account up” 2. Set the label according to needs. 3. After setting, pressing the button is to switch down the default account.
	Directory	<ul style="list-style-type: none"> - Use method: <ol style="list-style-type: none"> 1. The type is set to “directory” 2. Set the label according to needs. 3. After setting, pressing the button is to enter into the directory page.

4.8 Dial plan

Set the dial plan, the phone can dial conveniently according to the grammar set by the dial plan.

Note This function can only be set in the web interface.

4.8.1 Dial plan syntax

Before using the dial plan, you need to understand the dialing grammar. If you are already familiar with the grammar, you can skip this step and check the contents of the dialing plan function.

Symbol description of dialing rules:

Symbol	Description	Example
.	Represents any number of placeholders	Enter "78." match "786" "7856" "78911" "7857713" etc
x	Represents a placeholder	Enter "78x" match "781" "782" "783" "784" ... "789" etc
-	Indicates the interval range	Enter "[7-9]" match "7" or "8" or "9"
[]	Represents the interval range, there is only one [] in the string, used with the-symbol	Enter "12[7-9]45" match "12745" "12845" "12945"
()	Represents a combination of multiple ranges, there are multiple [] in the string.	Enter "([1-2][7-8])" match "17" "27" "18" "28"

Note If you have any questions about the syntax and usage of dialing rules, please contact your network administrator.

4.8.2 Dial plan function

Dialing rules include the following:

- Replace rule
- Call out immediately
- Area code
- Block out

4.8.2.1 Replace rule

You can set one or more (up to 100) substitution rules. A substitution rule refers to replacing one set of strings with another set of strings (refer to the above table for grammar). When the string you input matches the replacement rule, the string you input will be automatically replaced. This function is convenient for you to perform speed dialing. For example, a replacement rule is: "prefix: "1", replacement: "12345". When you want to dial "12345", just enter "1" and press the Send soft key. The phone

will dial out "12345".

- Add replacement rules through the web interface:

1. Click **Settings (E) -> Dial Plan(k) -> Replace Rules.**
2. Enter a character string in the prefix field (for example: 1).
3. Enter a character string (for example: 12345) in the replacement area.
4. Select the corresponding account in the account area (account 1/2/all)
5. Click **Add** to add a replace rule.

After adding the above rules, when you dial the number "1", press the **Send** soft key or # to make the call, the phone will automatically be replaced with "12345" for dialing.

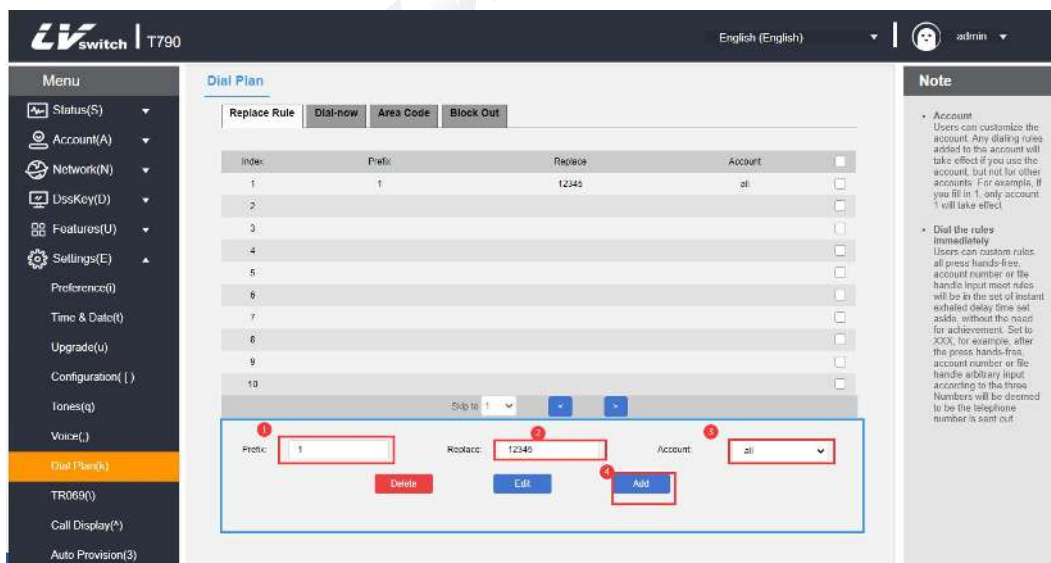

- Modify the replacement rule through the web interface:

1. Click **Settings(E) -> Dial Plan(k) -> Replace Rules.**
2. Check the box to the right of the rule.
3. Modify the values in the prefix area and replacement area.
4. Select the corresponding account in the account area, account 1/2/ALL.
5. Click **Edit** to modify the replacement rule.

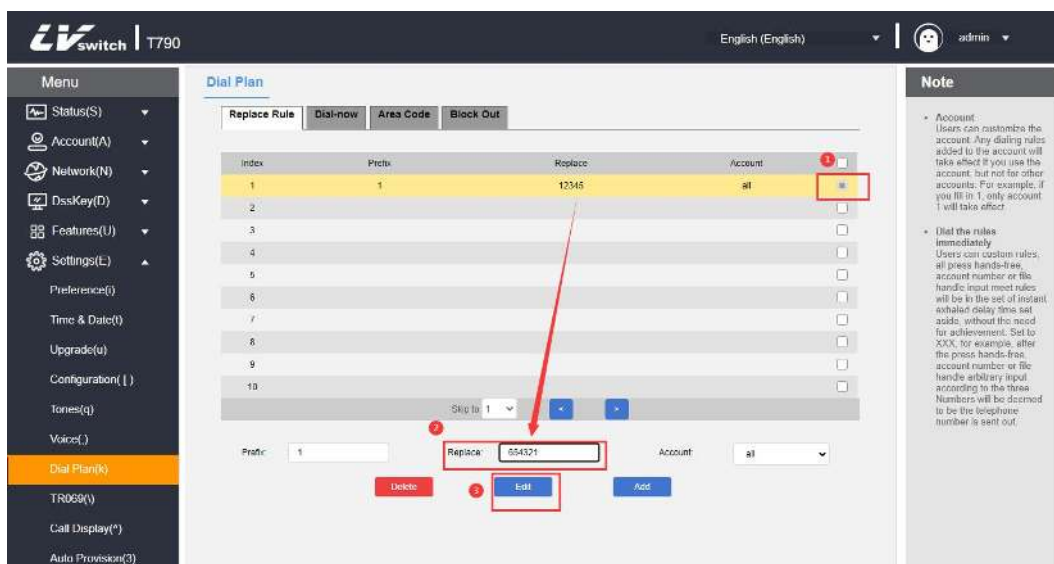

- Delete one or more replacement rules through the web interface:

1. Click **Settings(E)** -> **Dial Plan(k)** -> **Replace Rules**.
2. Check one or more check boxes to the right of the rule.

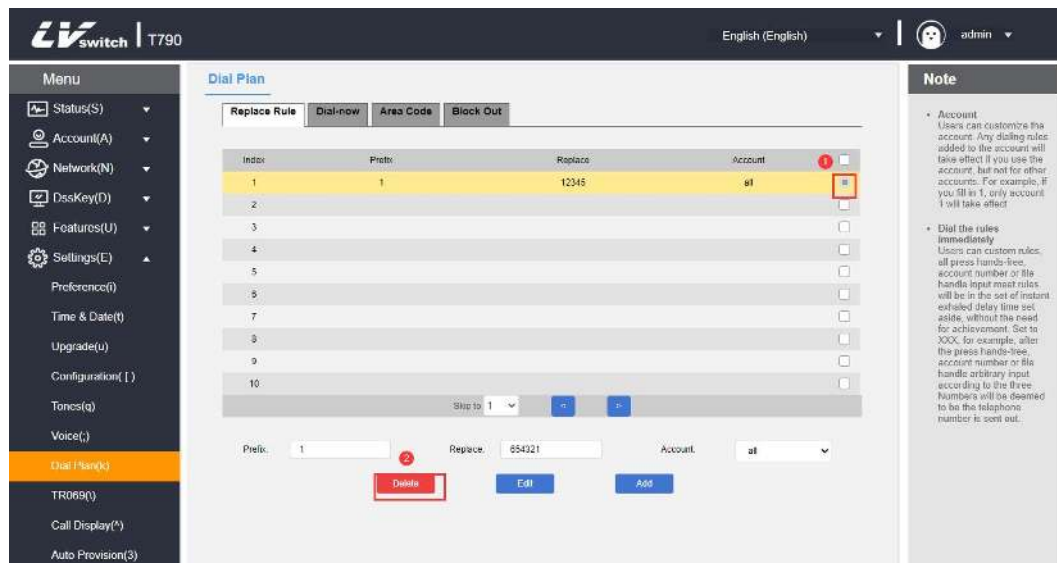

3. Click **Delete**.

4.8.2.2 Dial now rule

You can customize the immediate outgoing rules, up to 100. Any number that meets the rules by pressing the hands-free, account key or lifting the handle will be dialed out at the set instant outgoing delay time without pressing the send button. For example, when you set the outgoing rule to xxxxx and the calling account to all (any account), when you dial any five-digit number of 10086, the phone will immediately call 10086 when the outgoing rule is met.

- Add dial-now rules via web interface

1. Log in to the phone page by IP address.
2. Click **Settings(E)**->**Dial plan(k)**->**Dial-now**.
3. Enter the rule character to be set in the rule input area (such as: xxxxx).
4. Select the account that the dial-now rule applies to, account 1-4 or All. The default value is all (means all accounts).

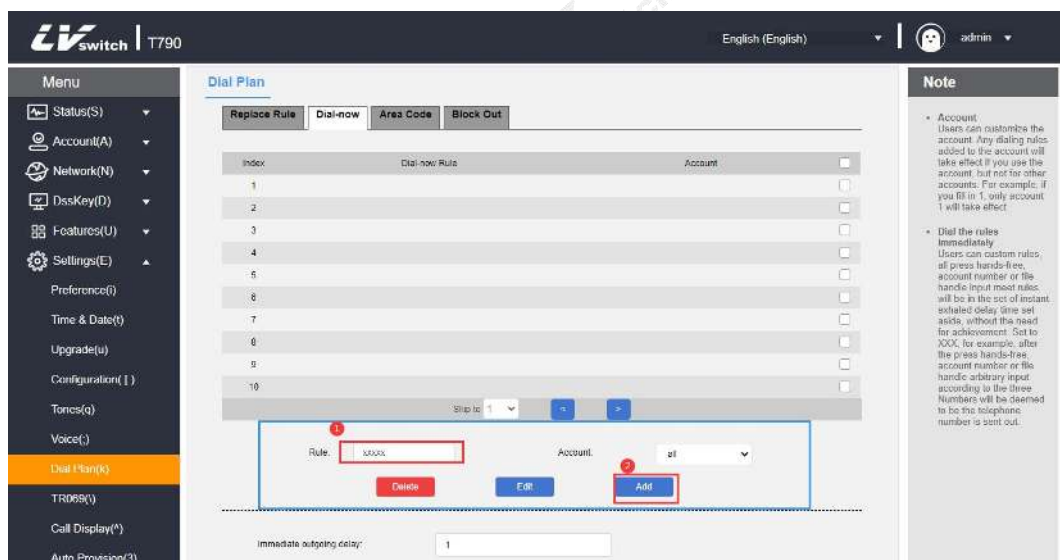

5. Click add button to save the rule.

When entering any five-digit number such as 10086, the call will be made immediately after waiting for the delay time.

- Modify the outgoing call rule through the web interface

1. Log in to the phone page by IP address.
2. Click **Settings (E) -> Dial plan (k) -> Dial-now.**
3. Click on the rule to be modified in the rule list.
4. Modify the rule in the rule input area, such as: (original: xxxxx --> change: 1xxxx).
5. Select the account that the dial-now rule applies to, account 1-4, or All. The default value is all (means all accounts).

6. Click the **Edit** button to save the modified rule.

- Delete the outgoing call rule through the web interface

1. Log in to the phone page by IP address.
2. Click **Settings (E) -> Dial plan (k) -> Dial-now.**
3. Click the rule to be deleted in the rule list.

4. Click the **Delete** button to delete the rule.

Immediate outgoing delay time:

You need to set the delay time for immediate outgoing calls. The default time is 1 seconds. The setting range is 0~14 (unit: second). When the number entered during dialing meets an immediate outgoing rule, the phone will automatically call this number after the delay time (You don't need to press the send button) .

- Set the delay time for immediate outgoing call through the web interface

1. Log in to the phone page by IP address.
2. Click **Settings (E) -> Dial plan (k) -> Dial-now.**
3. Fill in the time in the outgoing delay input area.
4. Click **Confirm** button to save operation.

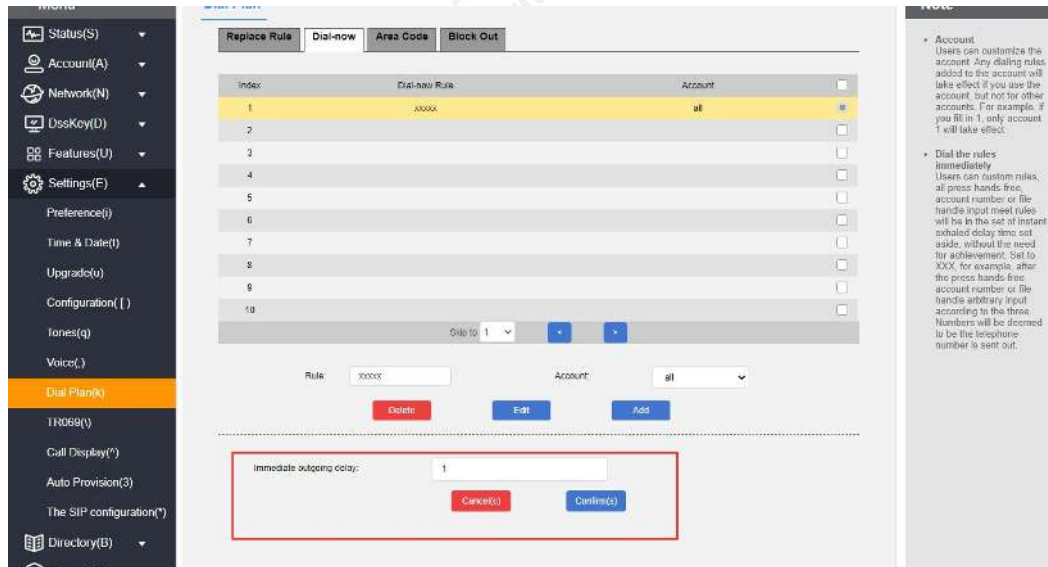

4.8.2.3 Area Code

Calls between different regions need to add the area code, which is different in different areas. If you need to dial the phone number of a certain area frequently, you need to manually add the area code prefix of that area. Use this function to automatically add an area code/prefix to your outgoing number.

Note Only one area code can be set for T790.

Example:

Set area number (length range: 1~15 digits)	0757
When you dial a number (length range: 1~15 digits)	12345
The number actually called is changed to	075712345

- Set area code via web interface

1. Log in to the phone page by IP address.
2. Click **settings(E)->Dial plan(k)->Area code.**
3. Fill in the area code in the area code (length range: 1-15 digits).
4. The account can fill in the registered account(account1-4) matching the area code or the default value is all (all accounts).

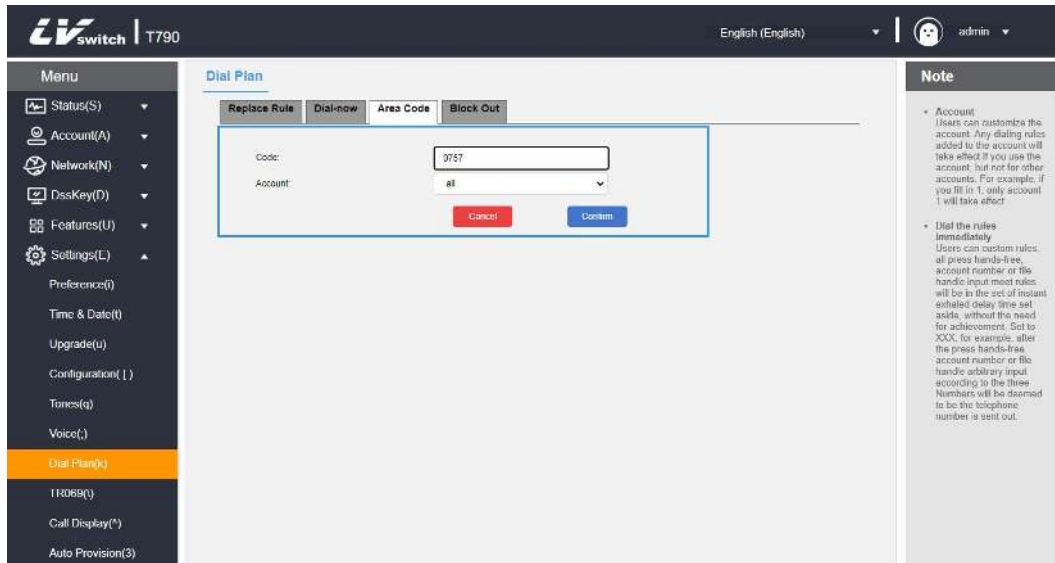

4.8.2.4 Limit outgoing calls

You can set restrictions on outgoing numbers and restrict the phone from dialing certain numbers. T790 supports up to 10 restricted outgoing numbers. When the number you call matches the rule, the phone LCD will display the words "Forbid Number".



- Add restriction rules through web interface

1. Log in to the phone page by IP address.
2. Click **Settings (E)** -> **Dial Plan (k)** -> **Block out** .
3. Fill in the number to be blocked out in the blocked out number field.

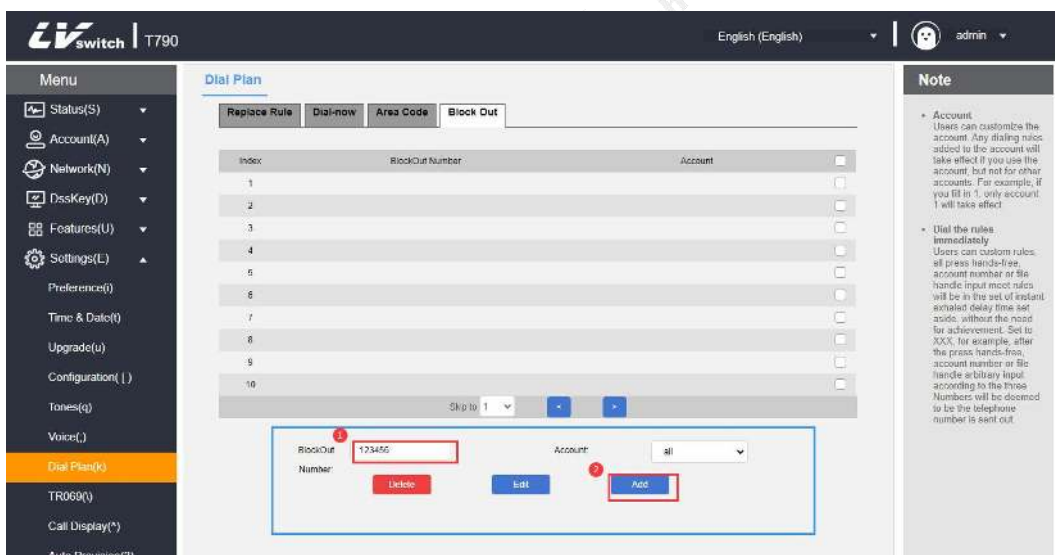

4. Select the account needs to block, account 1/2/all.
5. Click the **Add** button to save the rule.

- Modify the restriction rules through the web interface

1. Log in to the phone page by IP address.
2. Click **Settings(E)**->**Dial plan(k)**->**Block out** .
3. Click on the rule to be modified in the list of restricted outgoing rules.
4. Modify the rule in the rule input area, such as: (original: 800 --> changed: 111).
5. Select the account needs to block, account 1/2/all.
6. Click the **Edit** button to save the modified rule.

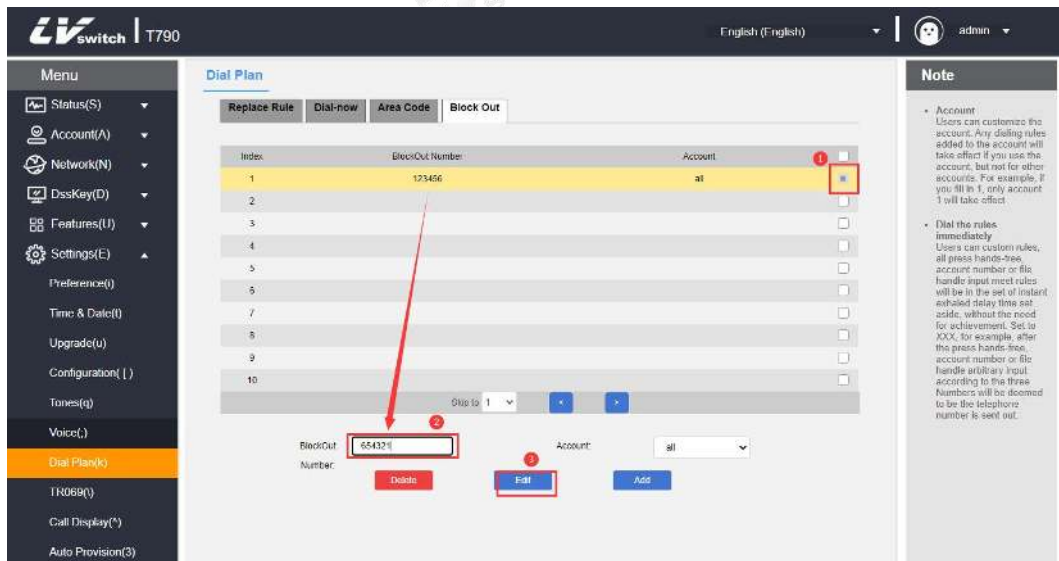

- Delete the restricted outgoing call rule through the web interface

1. Log in to the phone page by IP address.
2. Click **Settings (E)** -> **Dial plan(k)**->**Block out** .
3. In the list of restricted outbound rules, click on the rule to be deleted.
4. Click the **Delete** button to delete the rule.

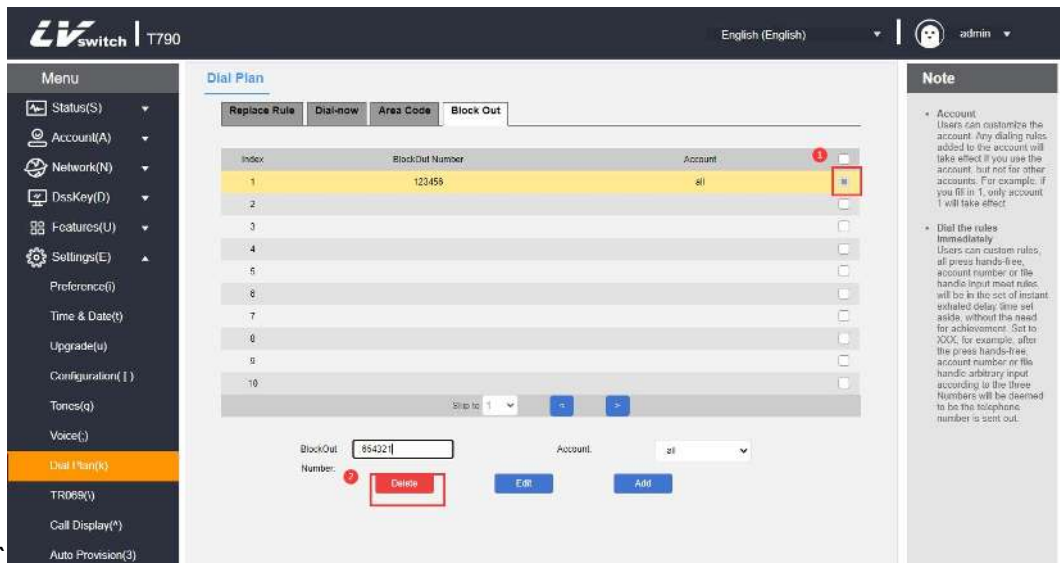

5. Basic function

This chapter mainly introduces the basic functions of the T790 phone, as follows:

- [5.1 Make a call](#)
- [5.2 Answer a call](#)
- [5.3 End a call](#)
- [5.4 Redial](#)
- [5.5 DND](#)
- [5.6 Call forward](#)
- [5.7 Call transfer](#)
- [5.8 Auto Answer](#)
- [5.9 Anonymous call](#)
- [5.10 Hotline](#)
- [5.11 QR code](#)
- [5.12 Conference](#)
- [5.13 Upgrade](#)
- [5.14 Upload ringtone](#)

5.1 Make a call

The way to make a call can be ① manual dialing, ② CDRs, local contacts select number dialing.





For the dialing method of CDRs and local contacts, please refer to [Contact Management](#) and [CDR Management](#).

T790 can use three tools to talk:

- Handle
- Headset
- Hands-free

- Use the handle to make a call







You can use any of the following methods:

Way 1	Way 2
1. Pick up the handle when the phone is idle	1. Enter the number in idle state
2. Enter number	2. Pick up the handle
3. Press  、  or Send softkey to make a call	3. Press  、  or Send softkey to make a call

Note The phone's default call-out key is #, you can also set it to * or not set this key as the call-out key. For detailed setting methods, please refer to the call-out key chapter.







- Use the headset to make a call

You can use any of the following methods:

Way 1	Way 2
1. After connecting the headset. Press  to enter headset mode.	1. After connecting the headset. Press  to enter headset mode.
2. Enter number	2. Press the account key to enter the dialing interface, enter the number
3. Press  ,  or Send softkey to call out the number	3. Press  ,  or Send softkey to call out the number

- Use hands-free for calls

You can use any of the following methods:









Way 1	Way 2
1. Press the hands-free  key to enter the dialing interface.	1. Enter the number in idle state
2. Enter number	2. Press  ,  ,  or Send softkey to call out the number
3. Press  ,  or Send softkey to call out the number	

Note The three communication tools can dial the number first and then make a selection.
You can dial the number by calling the IP address on the phone, check the IP address in the phone status of the other party, and then make the call by dialing the IP address, such as dialing: 192.168.0.123.

- Multi-way call

T790 supports multiple calls, each account supports up to 2 calls, while one call is in progress, the other call is on hold.

You can initiate a new call in any of the following ways:

Way 1	Way 2
1. During a call, press the Account key, the current call will be put on hold and enter the dialing interface.	1. During a call, press the Hold soft key, the current call will be on hold
2. Enter number	2. Press the New call soft key to enter the dialing interface, enter the number
3. Press  ,  or Send soft key to call out.	3. Press  ,  or Send soft key to call out.
4. Press  or  to shift number. Press the Resume soft key to resume the call	4. Press  or  to shift number. Press the Resume soft key to resume the call

5.2 Answer the call

T790 can use three tools to answer calls:

- Handle
- Headset
- Hands-free

- Use the handle to answer incoming calls

The phone rings and pick up the handle

- Use hands-free to answer calls

When the phone calls, press the **Answer** soft key or hands-free key 

- Use a headset to answer calls

When the phone calls

1. The headset mode is activated, press the **Answer** soft key or press the flashing account key to answer
2. The headset mode is not activated or activated, Press  Headset key to answer.

- Reject call

Press the **Reject** soft key to reject the call.

If DND is set, you can automatically reject incoming calls. For details, please see the [DND](#) section .

5.3 End the call

If you want to hang up during a call, you can use the following methods:

1. Use the handle: press the **EndCall** soft key or put the handle back to the phone.
2. Use hands-free call: press the **EndCall** soft key or hands-free key .
3. Use the headset to call: press the **EndCall** soft key.

5.4 Redial









The phone can quickly redial the last call or any call. Use the button  on the phone to redial. You can redial in different ways, the specific operations are as follows:

- Redial using the handle

1. Pick up the handle.
2. Press  to dial out the last call.

- Use hands-free to redial

Hands-free redial can use any of the following methods:

Way 1	Way 2
<p>1. Redial the last call</p> <p>Press  button twice to redial the last call</p>	<p>1. Press  to enter into hands-free.</p>
<p>2. Redial any call</p> <p>1) Press  button once.</p> <p>2) Press  or  to switch the number</p> <p>3) The press , Send soft key or  button to redial any one call.</p>	<p>2. Press  to redial the last call.</p>

- Redial using headset

You need to activate the headset mode first, please refer to the [headset usage](#) section for the specific activation method

1. Redial the last call

Press  button twice to redial the last call.

2. Redial any call

1) Press  button once.

2) Press  or  to switch the number.

3) The press , **Send** soft key or  button to redial any call.

5.5 DND

You can set the phone to the DND mode. After setting the DND mode, the phone will display an icon  in the upper right corner. When the phone receives an incoming call, it will not ring and inform the other party of the busy tone and display the message of missed calls on the phone. As shown below:



- Set do not disturb

You can choose the following two ways to set DND:

1. When the phone is idle, press the **DND** soft key to set.

2. Press **Menu->Features->DND**.
3. Press **Switch** soft key to enable or disable the function.
4. Finally, press the **Save** soft key to save the operation.

5.6 Call Forward

After the call forwarding is set to be enabled, the IP phone will automatically transfer to the other landline or mobile phone that is set for external calls. There are two types of call transfer. When the phone rings an incoming call, press the **Transfer** soft key to dial the number transfer (active transfer), when the phone has an incoming call, it will automatically transfer to the preset number (auto transfer).

5.6.1 Active transfer

- Transfer operation process

1. When there is an external call, the phone is ringing.
2. Press the **FWD** soft key.

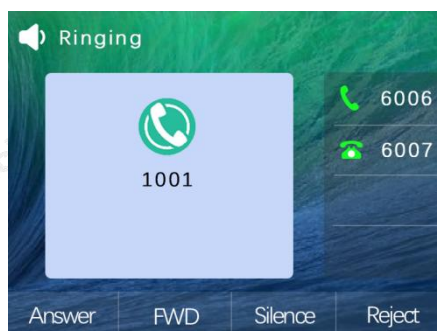

3. Enter the number to be transferred.
4. Press **OK** button /Send button ()/**Send** soft key, to transfer the incoming call.



5.6.2 Auto transfer

Automatic transfer is mainly divided into the following types:

- Unconditional transfer: all incoming calls on the phone will be transferred to the preset number.
- Busy transfer: When the phone is busy, the incoming call will be transferred to the preset number.
- No answer transfer: when no one answers the call during the ringing, it will transfer to the preset number after timeout.



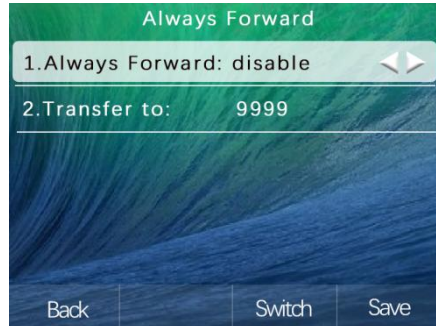

- Set up call forwarding through the phone interface

1. Press **Menu->Features->Call Forward**.
2. Select the transfer method to be set as needed:
 - ✧ Always Forward
 - 1) Press or to enter into Always Forward.

- 2) Press **Switch** soft key to enable or disable the function.
- 3) Press  or  to select the Transfer to term, fill in the always forward number.
- 4) Press the Save soft key to save the operation





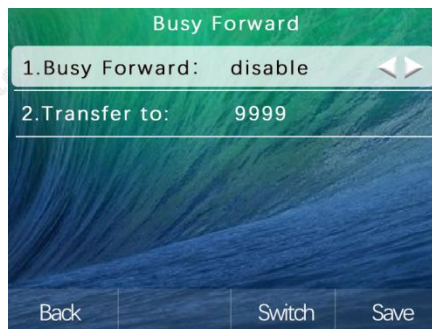

✧ Busy forward

- 1) Press  or  to select to enter into busy forward.
- 2) Press **Switch** soft key to enable or disable the function.
- 3) Press  or  to select the Transfer to term, fill in the busy forward number.
- 4) Press the **Save** soft key to save the operation.



✧ No Answer Forward

- 1) Press  or  to select No answer forward.
- 2) Press **Switch** soft key to select enable /disable.
- 3) Press  or  to select the number item, and fill in the number to be transferred.
- 4) Press  to select delay time, fill in the delay time before transferring.

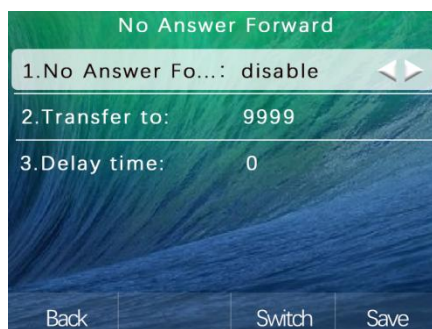

5) Press **Save** soft key to save the operation.

When the call forwarding function is enabled, the LCD screen of the phone will display an icon to enable call forwarding when the phone is in standby.

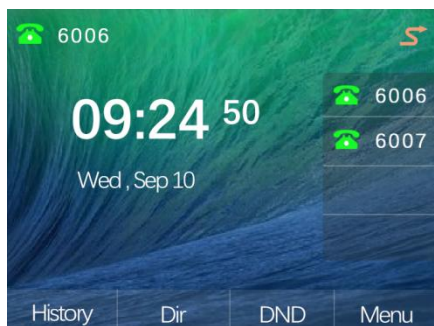

Note Can also use the Transfer button on the phone panel to quickly set up always forward.

5.7 Call Transfer

There are two types of call transfer:

- Blind transfer: No need to negotiate with the transferee, directly transfer to the other party.
- Inquiry transfer: After negotiating with the transferee and agreeing to transfer, transfer the call to the other party.

5.7.1 Blind Transfer

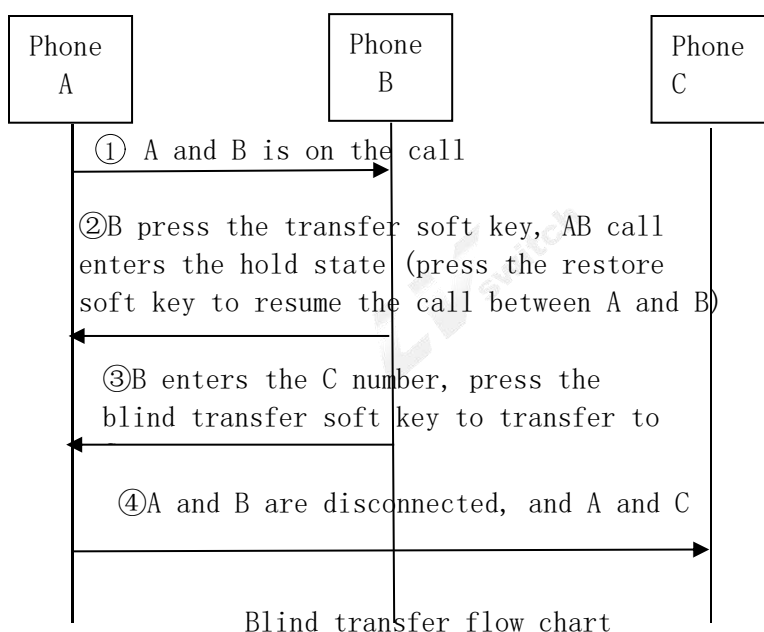





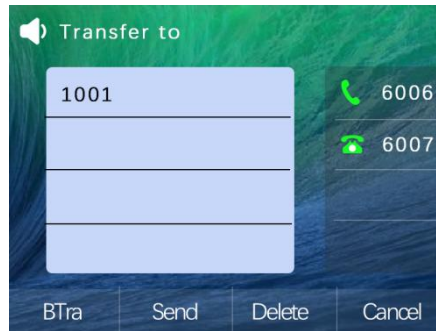

- Blind transfer operation process:

1. Phone A and phone B is on the call.

2. Phone B press the **Trans** soft key or transfer button.
3. The called number for blind transfer can be entered in the following two ways:
 - a) Enter the number directly
 - 1) B enters the number of phone C to be transferred, and the LCD screen of phone B shows the **Btra** soft key after entering the number.
 - 2) B press the **Btra** soft key.
 - 3) The call between phone B and phone A will be interrupted, and the call will be transferred to phone C.



- b) Select number by contact
 - 1) B press the Dir soft key.
 - 2) Press  or  to select the group, press **Enter** soft key into the group.
 - 3) Press  or  to select the contact you want to transfer, and press the **Send** soft key.
 - 4) Press  or  to select the number or mobile phone number, press **Trans** soft key to transfer.
 - 5) The call between phone B and phone A will be interrupted, and the call will be transferred to phone C.



- The process of canceling the blind transfer:

When phone A and phone B are in a conversation, after phone B presses the transfer soft key, phone B and phone A enter the call hold state, and the caller will hear the call hold ringtone. If you want to exit the transfer operation, press the resume soft key to resume the call between phone B and phone A.

5.7.2 Inquiry transfer

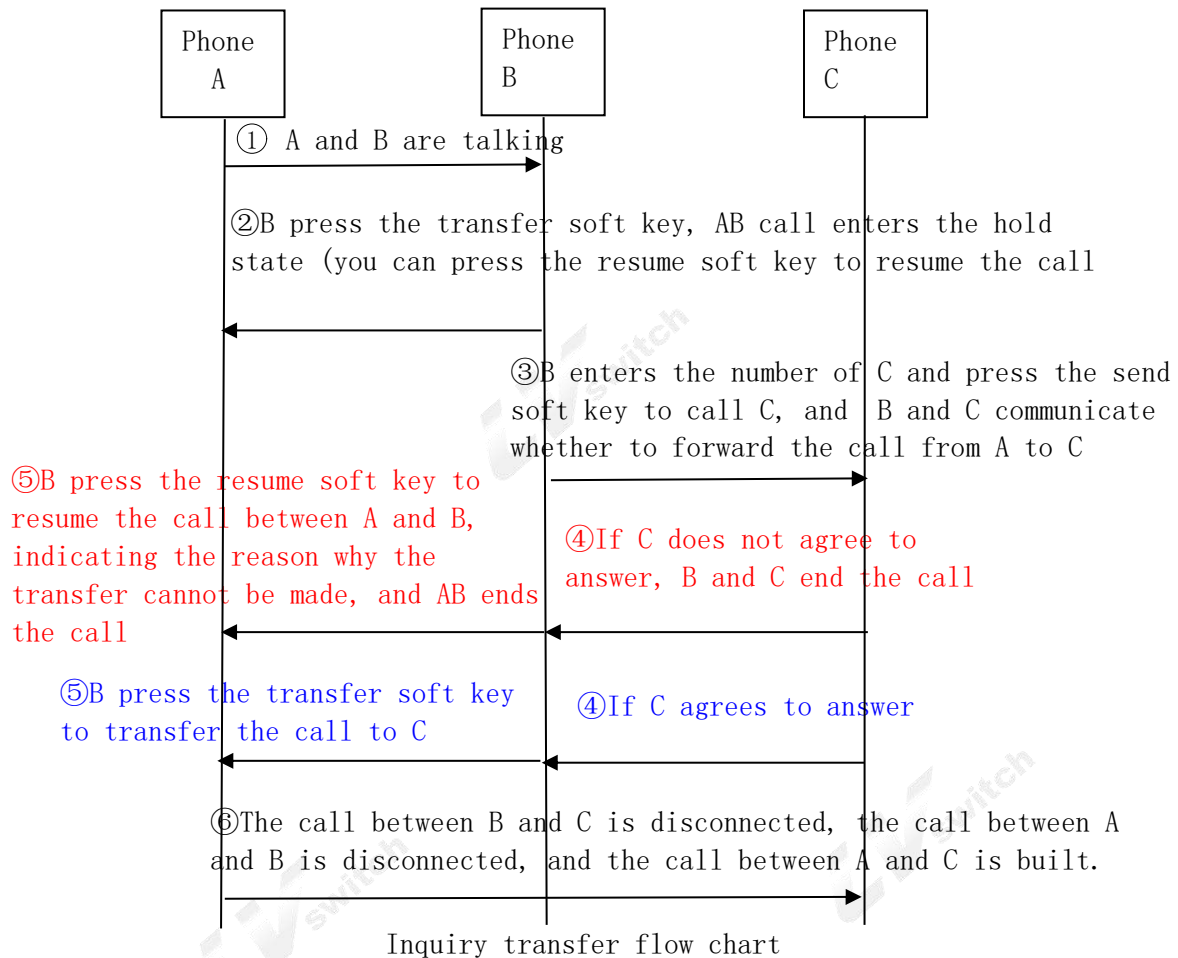

- Inquiry transfer operation

1. Phone A and B are talking.
2. B press the **Trans** soft key or transfer button.
3. Enters the number C needed to be transfer,the LCD displays the **Send** soft key.
4. Press **Send** soft key,B and C are talking and inquire C whether to answer A calling.
5. There are two conditions:
 - a) Phone C can't answer the calling
 - 1) Phone C refuses to answer A's call or phone C is unanswered.
 - 2) Phone B and C end the calling.
 - 3) Phone B presses the Resume soft key to resume the call with phone A, and informs that phone A cannot answer.
 - 4) The transfer is end.
 - b) Phone C can answer the call.
 - 1) After the negotiation between phone B and phone C is completed, phone C can answer the call from phone A.
 - 2) Phone B press the **Trans** soft key.
 - 3) The call between phone B and phone A will be interrupted, the call will be transferred to phone C, and phone A and C will talk.

5.8 Auto Answer

You can set up the auto answer function for the registered account of the phone. When the account with auto answer turned on receives an incoming call, the phone will automatically answer the call after the set auto answer waiting time.

- Set auto answer via phone interface

1. Press **Menu->Features->Auto Answer**.
2. Press **Switch** soft key to select the auto answer account.
3. Press the **Switch** soft key to switch the enabled or disabled state.
4. Press the **Save** soft key to save the operation.

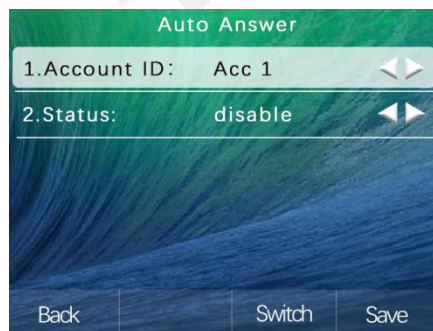

After the phone is enabled for automatic answering, an automatic answering icon  appears on the standby display interface of the phone, Indicates that the phone is in automatic answering state. When the phone is in a call, it will no longer answer automatically.



5.9 Anonymous Call

The phone can enable the anonymous rejection function. When there is an anonymous call, it will automatically reject the call. If the server supports the anonymous rejection function, you can also turn on/off the anonymous rejection function of the account by dialing the service code of the server.



- Set the anonymous rejection function through the phone interface

1. Press **Menu ->Features->Anonymous Rejection**.
2. Press the **Switch** soft key to switch the enabled or disabled state.

3. Press the **Save** soft key to save the operation.



- Set the anonymous call function through the phone interface



1. Press menu ->**Features**->**Anonymous Rejection**.
2. Press  or  to select local anonymous option.
3. Press the SWITCH soft key to switch the status of enabling or disabling local anonymity.
4. Press the save soft key to save the operation.



5.10 Hotline

You can set frequently dialed numbers as hotlines. When using the hotline, when you pick up the handle, press the handsfree, and use the headset for dialing operations, after waiting for the hotline delay time, the phone will automatically dial the set hotline number. If the delay time is set to 0, the hotline number will be automatically dialed out immediately when dialing.

- Set the hotline function through the phone interface

1. Press **Menu**->**Features**->**Hotline**.
2. Fill in the hotline number.
3. Press  or  to select hotline delay time, fill in the number of seconds after

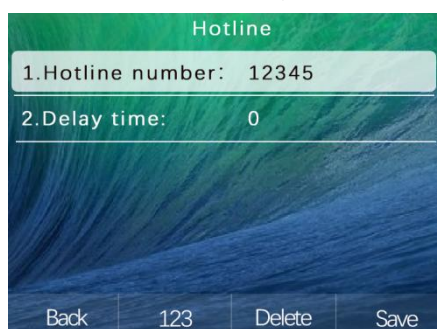

- picking up the phone to automatically call the hotline.
- 4. Press the **Save** soft key to save the operation.

5.11 QR code

T790 supports scanning the QR code provided by the phone through a smart phone to enter the web interface, so as to configure the phone information on the phone. Before scanning the QR code, the phone must be connected to the local area network to which the phone belongs, and in the same network segment as the phone, such as connected to the WIFI of the router.

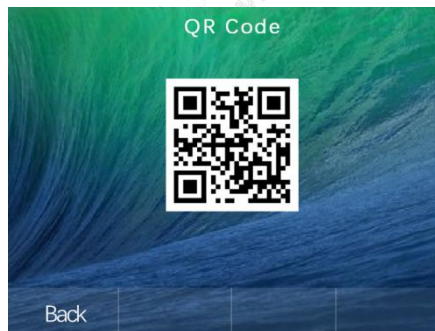

The interface of the mobile phone login phone belongs to the following figure. The specific usage method is the same as that of the computer web page. If you want to know the configuration method of each function, please check the function introduction of each chapter. If you have any questions about the use of the QR code, please contact your network administrator.

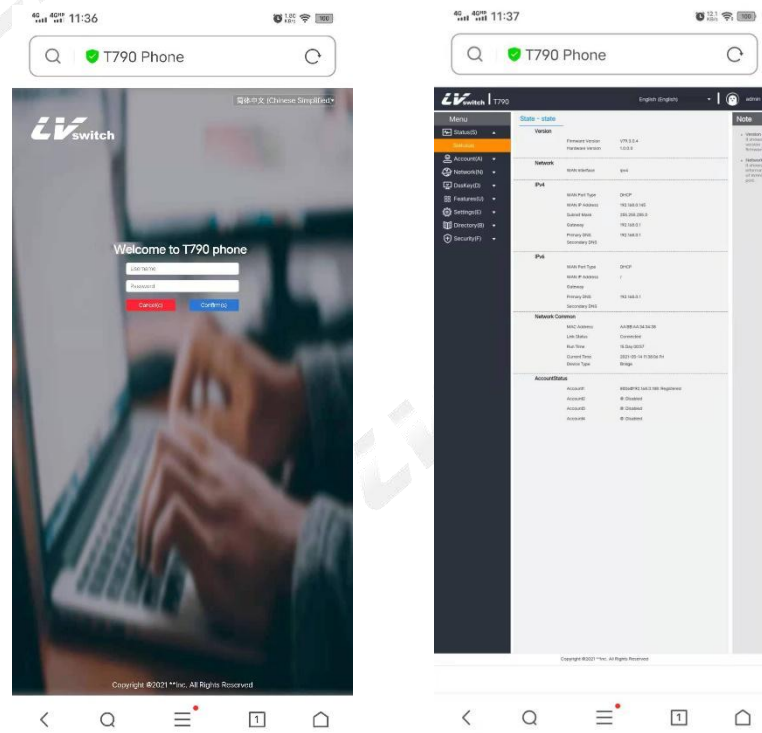

5.12 Conference

T790 can initiate a three-party call locally, and use the conference softkey during a



two-party call to invite a third-party call to the current call.

- Create a local three-way call on the phone

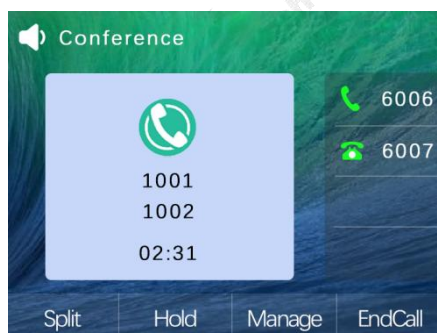
1. A and B are talking.
2. A presses the conference soft key to initiate a three-party call, the call between A and B enters the hold state, and A enters the dialing interface.
3. A press C number, and press **Send** soft key.
4. When C answers the call, A presses the **Conf** soft key, and ABC will start a three-way call.



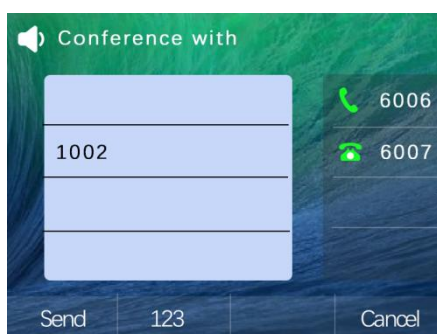

- Add calls from two accounts to a three-way call

1. Phone A's **account 1** is talking with phone B, and phone A's **account 2** is talking with phone C (but it is on hold).
2. If account 1 is calling and account 2 is on hold, press  or  to switch the call, Using account 1 that is currently in a call, press the **Conf** soft key to enter the dialing page, press  to select the held call, and press the **Send** soft key to start a three-way call.



- Operations that can be performed during a three-way call

1. **Split** soft key: Split three-way calls into multiple independent calls, press  or  can shift the call.
2. **Hold** soft key: You can put the other two parties on hold and press the Resume soft key to resume the three-way conversation.
3. **Manage** soft key: Enter the manage page, you can perform the following operations for the other two parties:
 - 1) **Delete** soft key: Delete selected conference members
 - 2) **Hold** soft key: Hold selected conference member

3) **Back** soft key: Return to the previous screen



4. **Mute** soft key: So that the other two parties cannot hear your voice, and the other two parties can still talk .

5. **Hang up soft key**: End the meeting.

5.13 Upgrade

The T790 phone can be upgraded to the latest version via the Web, the latest version can be downloaded from the official website or contact your seller to obtain.

- Upgrade firmware version via web

1. Through the web interface, click **Settings -> Upgrade -> Upgrade Firmware**, select the version that needs to be upgraded, and click Upgrade.
2. It is forbidden to disconnect the power supply and network during the upgrade process, otherwise irreversible problems may occur, and the system cannot be turned on.

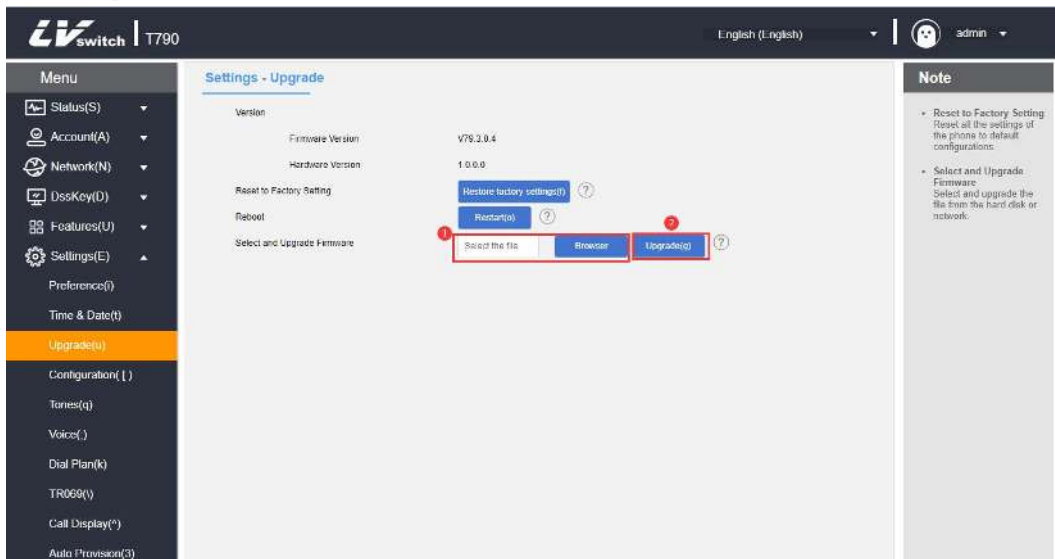

5.14 Upload ringtone

T790 phones can upload custom ringtones via the Web.

- Upload custom ringtones via the web

1. Through the web interface, click **Settings -> Preference -> UpLoad Ringtones**.

2. Select the ringtones in **Upload Ringtone** field, and Click Import button upload your own ring tone (the maximum limit of ringtones is 100KB).
3. After the upload is successful, you can choose your ring tone from the Ring Type field.

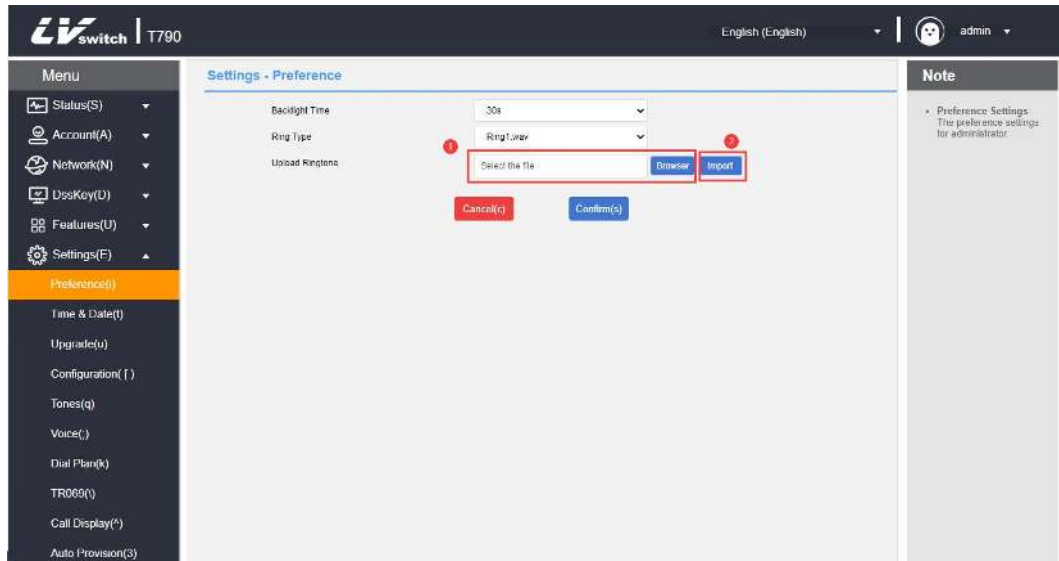

6. Advanced Features

This chapter mainly introduces the advanced functions of the T790 phone, as follows:

- [6.1 BLF](#)
- [6.2 Intercom](#)
- [6.3 Multicast](#)
- [6.4 Message](#)
- [6.5 TR069](#)
- [6.6 Configuration management](#)
- [6.7 Auto Provision](#)
- [6.8 SIP configuration](#)
- [6.9 Action URL](#)
- [6.10 Trusted Certificates](#)

6.1 BLF (Busy Lamp Field)





You can use the BLF function to monitor the status of a user's account. For example, you can configure a BLF key on the phone to monitor the usage status of a colleague's account (busy or idle). When a colleague's account is busy, the LED of the BLF key lights up red, indicating that the colleague's account is busy.

Configure BLF function:

You can configure the BLF monitoring function on the phone, and the monitored phone does not need to be configured.

6.1.1 Configure BLF button

- Configure the BLF button via the phone interface

1. Press **Menu->Features-> Dess KEYS**.
2. Select the account key which needed to set BLF key.
3. Press  or  key to switch,select BLF in the type area.
4. Press  or  key to switch ,select the corresponding account in the account ID area.
5. (Optional) Enter the label displayed on the standby interface in the label area.
6. Enter the number to be monitored in the value area.
7. (Optional) Enter the pick-up feature code in the extension area, which needs the support of the SIP server.
8. Press the **Save** soft key to save the operation or the Return soft key to cancel the operation.

- Configure the BLF button via web interface

1. Click **DSS KEYS**→ **Line Key(W)** on the web interface.
2. Select the account key that needs to set up BLF.
3. Select BLF in the type drop-down box.
4. Enter the account to be monitored in the value field input box.
5. (Optional) Enter the label displayed on the standby interface in the label input box.
6. Select the corresponding account in the account drop-down box.
7. (Optional) Enter the call pickup feature code in the extension input box, which needs the support of the SIP server.
8. Click **Confirm** to save the operation or cancel to abandon the operation.

6.1.3 Use BLF Function

The method of using the BLF key is as follows:

- **Call the monitored account:**
When the monitoring account is idle, press the BLF key and the phone will call out the monitoring account.
- **Answer calls from monitored accounts:**
When the monitored account gets a call, the LED light of the BLF button corresponding to the monitored account flashes red. If the extension number is configured as a pickup feature code, press the BLF key, and the incoming call of the monitored account will be answered.

6.2 Intercom



By setting the account key as a walkie-talkie function, you can quickly dial out the set called number when you press the account key, and you can quickly connect to your secretary or operator in an office environment. The intercom callee will automatically answer the intercom call.

6.2.1 Set the intercom function button

Before using the intercom function, please make sure that the server supports the intercom function and you need to set the account key function as the intercom button. For the detailed setting method, please refer to the [programmable button](#). If you need help, please contact your network administrator.

6.2.2 Intercom function setting

- Turn on the intercom through the phone interface

1. Press **Menu->Features->Intercom**.
2. Press  or  to select intercom function.
3. Press switch soft key to open/close it.
4. Press the **Save** soft key to save.

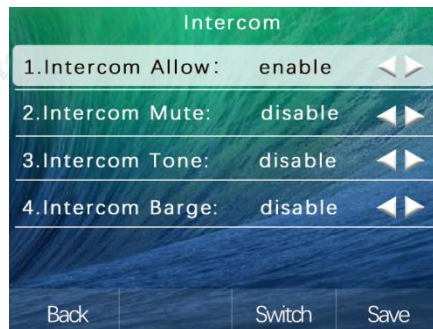

- Turn on the intercom through the web interface

1. Log in to the phone page by IP address.
2. Click **Function (U) -> Intercom (n)**.
3. Select to enable the intercom function.
4. After selecting, press the **Confirm** button to save.

6.2.3 Intercom function description

Function	Description
Allow Intercom	After enabling, if there is an intercom call, the phone will be automatically connected, otherwise the intercom call will be treated as a normal call
Intercom mute	Use with the intercom function, automatically connect the intercom call in silent mode after it is turned on;
Intercom tone	Use with the intercom function, after turning on



	the intercom call will beep before connecting
Intercom barge	Use with the intercom function. After turning on the phone, if there is an intercom call when the phone is in a call state, the intercom will be connected directly

6.3 Multicast

Multicast allows you to send time-sensitive announcements to each member of the multicast group simply and quickly. Send the RTP stream to the pre-configured multicast address through the multicast key or multicast list set on the phone. By setting the monitoring multicast address on other phones, the phone can monitor and play the RTP stream sent by the multicast address. The multicast process does not involve SIP signaling. The phone can be set to monitor up to 31 multicast addresses.

6.3.1 Multicast configuration

- Configure the multicast key through the phone

1. Press **Menu->Features->Dess keys**
2. Select the account key that needs to set up multicast.
3. Press  or  key to switch, select key event in the **Type** area.
4. The key type is paging
5. (Optional) Enter the content displayed on the standby interface in the **Label** area
6. Enter the multicast address IP address + port number in the **Value** field, and the IP range is 224.0.0.0-239.255.255.255.
7. Enter the corresponding channel number in the **Channel** area: 0-30.
8. Press the **Save** soft key to save the operation or press the Back soft key to cancel the operation.

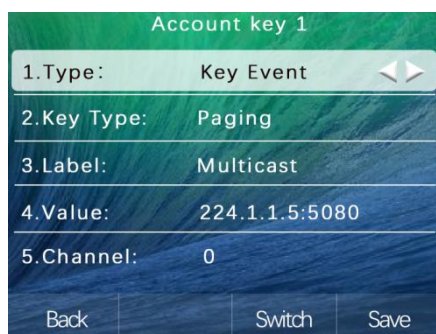

- Configure the Multicast key via web interface

1. Click **DSS KEY--Line Key(W)** on the web interface.
2. Select the account key that needs to set up multicast.
3. The drop-down box of the type area is set to multicast.
4. In the value field input box, fill in the multicast address IP address + port number, and the IP range is 224.0.0.0-239.255.255.255.
5. (Optional) Enter the content displayed on the standby interface in the label area.

- Enter the corresponding channel number in the extension area: 0-30.
- Click **Confirm** to save the operation or cancel to abandon the operation when finished.

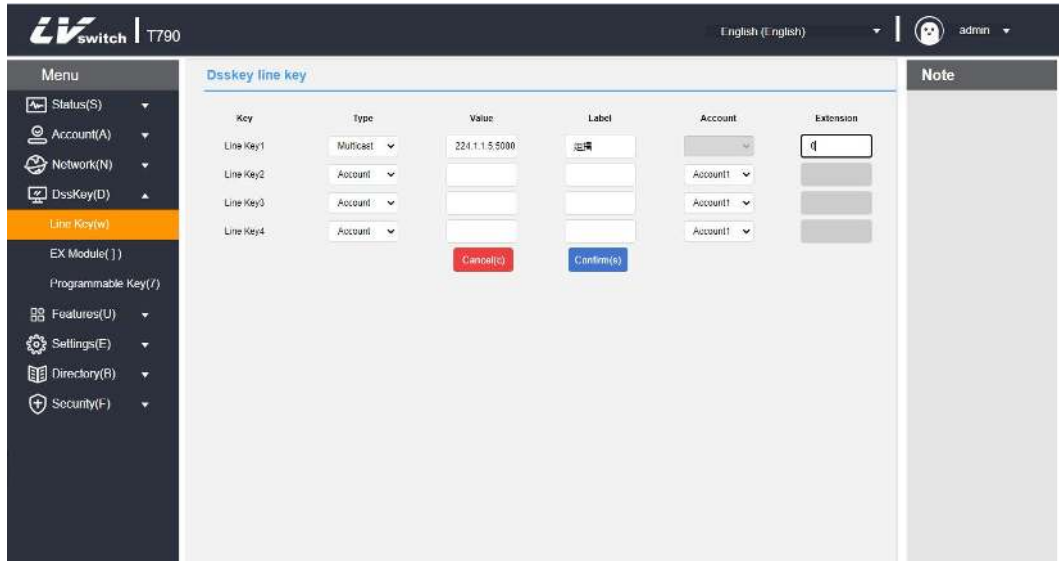

6.3.2 Paging list configuration

- Configure paging list via phone interface

1. Press **Menu->Features->Paging list** .
2. Press or to select the corresponding group.
Before configuration, the label is empty.



3. Press **Option** soft key then press **Edit** soft key.
4. Enter the multicast IP address and port number in the **Address** field (for example: 224.5.6.20:10008).
5. Enter the group name in the **Label** field.
6. Enter the corresponding channel number in the **Channel** area.
The valid channel numbers are from 0 to 30.
7. Press **Save** soft key to save the operation.
8. Repeat steps 2-7 to add more groups.

- Configure paging list via web interface

1. Click **Directory- Multicast IP-Paging list**.
2. Fill in the multicast address IP address + port number in the multicast address input box (for example: 224.5.6.20:10008).
3. Enter the group name in the **Label** area.

4. Select the corresponding channel number in the channel drop-down box.
5. Click **Confirm** to save the operation when finished.

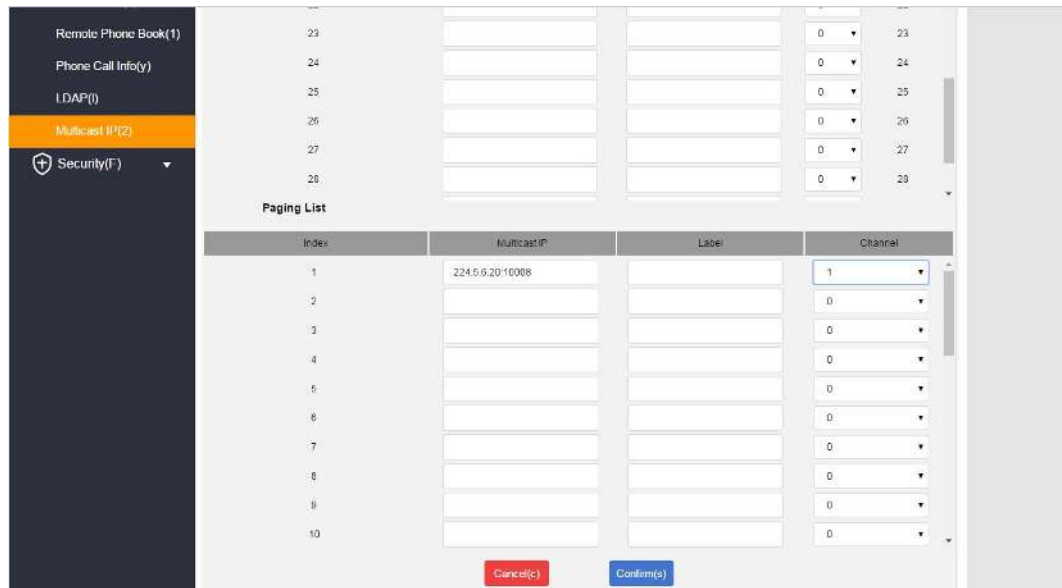

- Delete multicast group via phone interface

1. Press menu-Features -Paging list.
 2. Press or to select the corresponding group.
 3. Press option soft key then press Delete key.
 4. The phone LCD screen prompts "Delete group?".
 5. Press the **OK** soft key to delete.
- To delete all multicast groups, press the Delete All soft key.

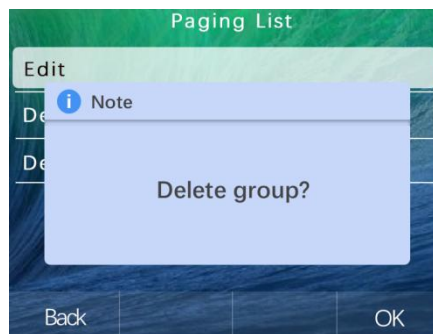

You can also set the way the phone receives RTP streams through the Web, which can be divided into paging intervention, DND penetration, and paging priority. Configure the path: Directory → multicast address.

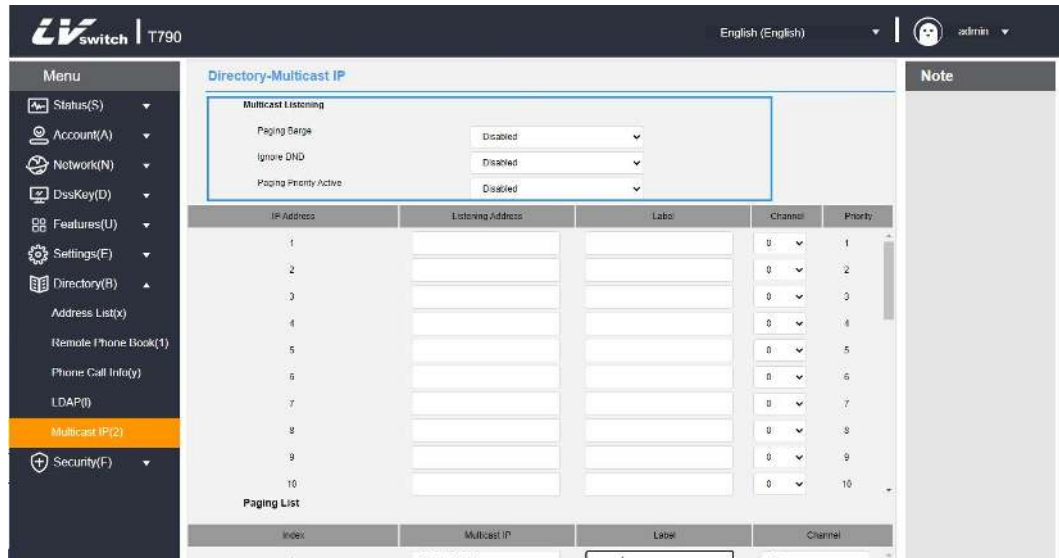

6.3.3 Receive multicast RTP stream

You can set the phone to receive the multicast RTP stream sent from the pre-configured multicast address. The multicast process does not involve SIP signaling. Up to 31 different multicast addresses can be configured to monitor on the phone.

Note RTP multicast monitoring is played in hands-free mode by default. If you want to play in other modes (hands-free, handset or headset), please consult your system administrator.

- Paging intervention:** If there is multicast during the call, if the current multicast priority is lower than the call priority, the phone will automatically ignore the multicast; disable it to ignore all multicasts, the range is 1-31. For example, if the priority is set to 1, the multicast with priority 2-31 is ignored.
- Penetrate DND:** If the phone is enabled to penetrate DND, priority is 3; when the phone is enabled in the DND mode, multicasts with a priority greater than or equal to three can be answered normally;
- Paging priority:** If you enable paging priority, when the phone is listening to the multicast RTP stream with priority 5, at this time the multicast RTP stream with priority 3 is sent, and the phone will automatically receive priority 3 Multicast RTP stream.

- set the listening multicast address via the web interface

- Click **Directory-- Multicast address**
- Select the appropriate value in the drop-down box of Paging Intervention.
- Select Enable in the drop-down list of Paging Priority.
- Enter the monitored multicast address in the monitoring address field: IP address and port number (for example: 224.5.6.20:10008)

5. (Optional) Enter a label in the label area. When a multicast RTP stream is received, the LCD interface will display the multicast label.
6. Select the corresponding channel in the channel drop-down box, the default is 0.
7. Click **Confirm** and save the operation.

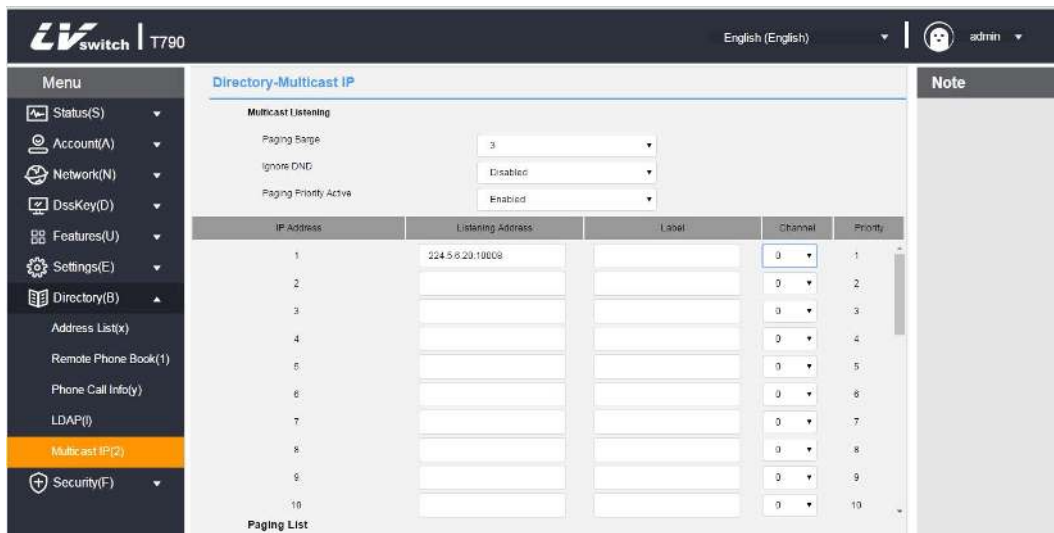

Note The priority of the listening address is defined in advance: 1 is the highest priority, and 31 is the lowest priority. You can only set the monitored multicast address through the web interface.

6.3.4 Multicast use

Phone A has set up account 1 as multicast, account 2 as the multicast list, phone B, C, D, etc., set the listening address;

1. **Multicast key sending:** When phone A is in standby mode, press the account 1 multicast key, and the pre-configured monitor phone will receive the multicast RTP stream; if phone A presses the hold key, the receiver will automatically hang up the multicast RTP session. Press the restore button to restore the held multicast. Press Hang up to end the multicast RTP session.
2. **Multicast list sending:** Press Multicast List in the standby state, select the option that needs multicast and press Multicast, or press Menu->Function->Multicast List in the standby state.

Precautions:

1. The multicast RTP stream is one-way, only from the sender to the receiver.
When the phone is in a call, initiate a multicast RTP session and the current call is on hold;
2. Multicast will not generate call records.

6.4 Message

6.4.1 SMS

The SIP-T790 IP phone can send and receive text messages. When a new text message is received, the phone will emit a “di beep” prompt, the power indicator will flash red slowly, and the LCD interface will prompt “n new text messages” (n represents the number of unread text messages, for example: 1 New text messages), and display the icon of unread text messages .

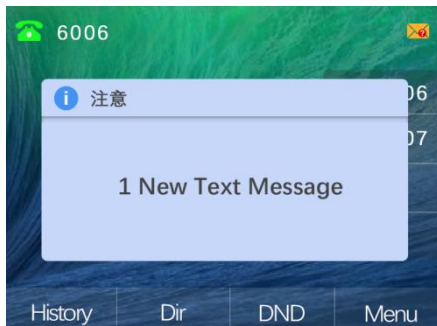

Text messages can be stored in Inbox, Sentbox, outbox and draft box, each of which can store 100 text messages. If the number of SMS exceeds 100, the phone will directly delete the oldest SMS.

- To read text messages

1. Press **Menu->Messages->Text message->Inbox.**
2. Select the information you want to read and press the **View** soft key.

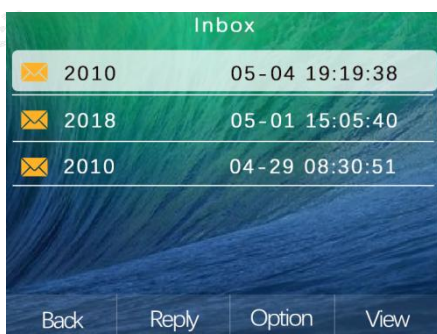

Note If the phone prompts you to receive a new text message, you can directly press the View soft key to read it.

- Send text messages

1. Press **Menu ->Messages -> Text messages ->New Message**
2. Write new message, press the **abc** soft key to switch the input method.
3. Press **Send** soft key.

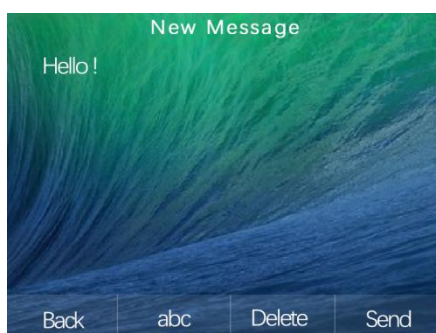

4. (Optional) Press the **Switch** soft key and select the sender account in the

sender area.

5. Enter the recipient number in the send to field.
6. Press the **Send** soft key to send the message or the **Back** soft key to cancel.

- Send text messages through the web interface

1. Log in to the phone page by IP address
2. Click **Features(U) -> SMS(9)**.
3. Input **Send number**.
4. Type the **Send Content**.
5. Press **Confirm** button to send the message.

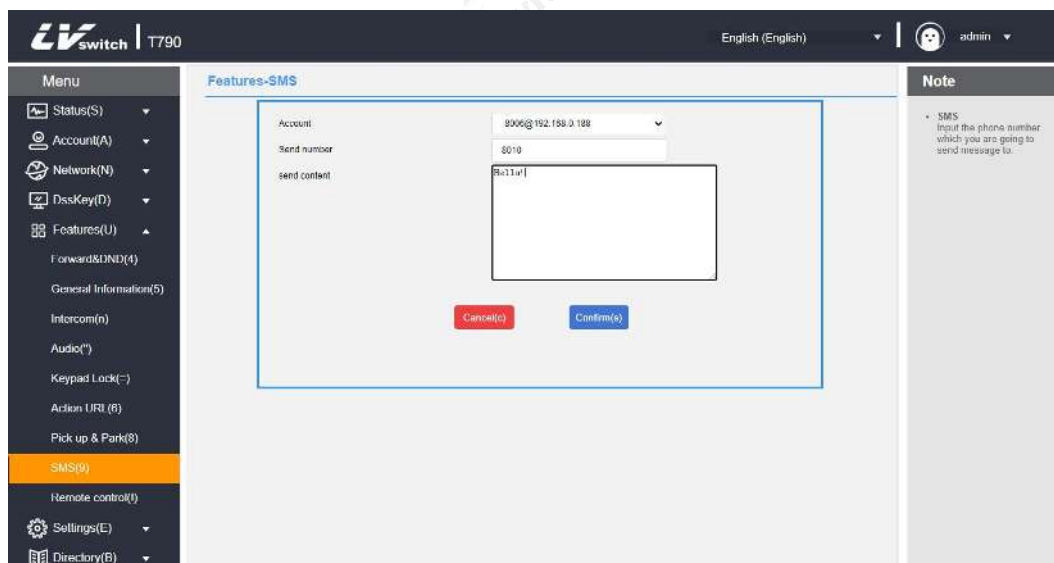

- To reply text messages

1. Press **Menu ->Messages -> Text messages ->Inbox**
2. Select the message you want to reply, and press the **Reply** soft key.
3. Write message, press **abc** to switch input methods.

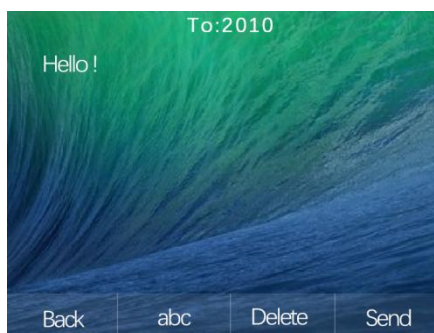

4. After editing, press **Send** softkey.
5. Check the **Sender** and **Send to** area.
6. Press the **Send** soft key.

- Delete text messages:

1. Press **Menu ->Messages -> Text messages ->Inbox(Sentbox, Outbox, Draftbox)**.
2. Select the information to be deleted, press the **Option** soft key.
3. Select Delete, and then press the **OK** soft key. The LCD interface displays

"Delete the selected message?".

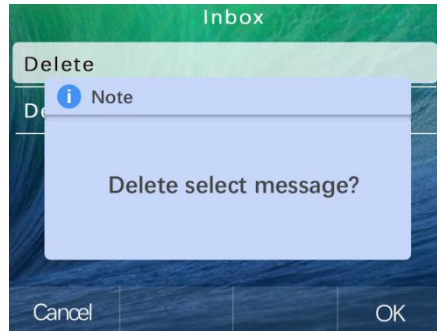

4. Press the **OK** soft key to delete and press the Cancel soft key to cancel.
To delete all short messages, press the Option soft key and select Delete all.
For more information, please refer to the steps above.

Note You can directly press the Delete soft key to delete the message after receiving and viewing the specific short message.

6.4.2 Voicemail

SIP-T790 phone can send and receive voice messages. You can subscribe to the voice messages buffered in the voice mailbox on your phone. This function requires the server to be preset. Not all servers support voice mail.

When a new voice mailbox is received, the phone's power light flashes slowly in red, and the LCD interface displays "N New VoiceMail" (N represents the number of unread voice messages, for example: 3 new voice messages), and a voice message

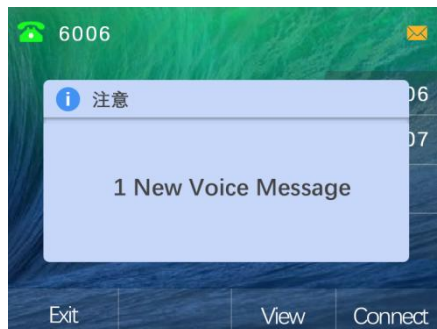

icon  is displayed.



- Send voice message:

When the calling user is busy or inconvenient to answer the call, you can leave a message according to the voice prompt of the server, and hang up after leaving the message.

- Set the voice message access feature code through the phone interface:

1. Press **Menu->Messages->Voicemail->Set voicemail code**;
2. Press  or  to select the account needs to set;
3. Enter voice message access feature code(For example:*97);
4. Press the **Save** soft key to save or Return to cancel the operation.

- Listen to voice messages

1. After setting the voice feature code, press the SMS soft key or call out the voice message access feature code.
2. Just follow the voice prompt to listen to the voice message.

- View voice messages

1. Press **Menu** -> **Messages** -> **Voice Message** -> **View Voice Message**.
2. Select the account you want to listen to and press the **Connect** soft key to answer the voice message.

6.5 TR069

TR069 is a communication protocol for communication between CPE and ACS. CPE can use this agreement to complete the necessary actions such as service activation, function setting, file upload and download, system detection, etc. initialization and operation management.

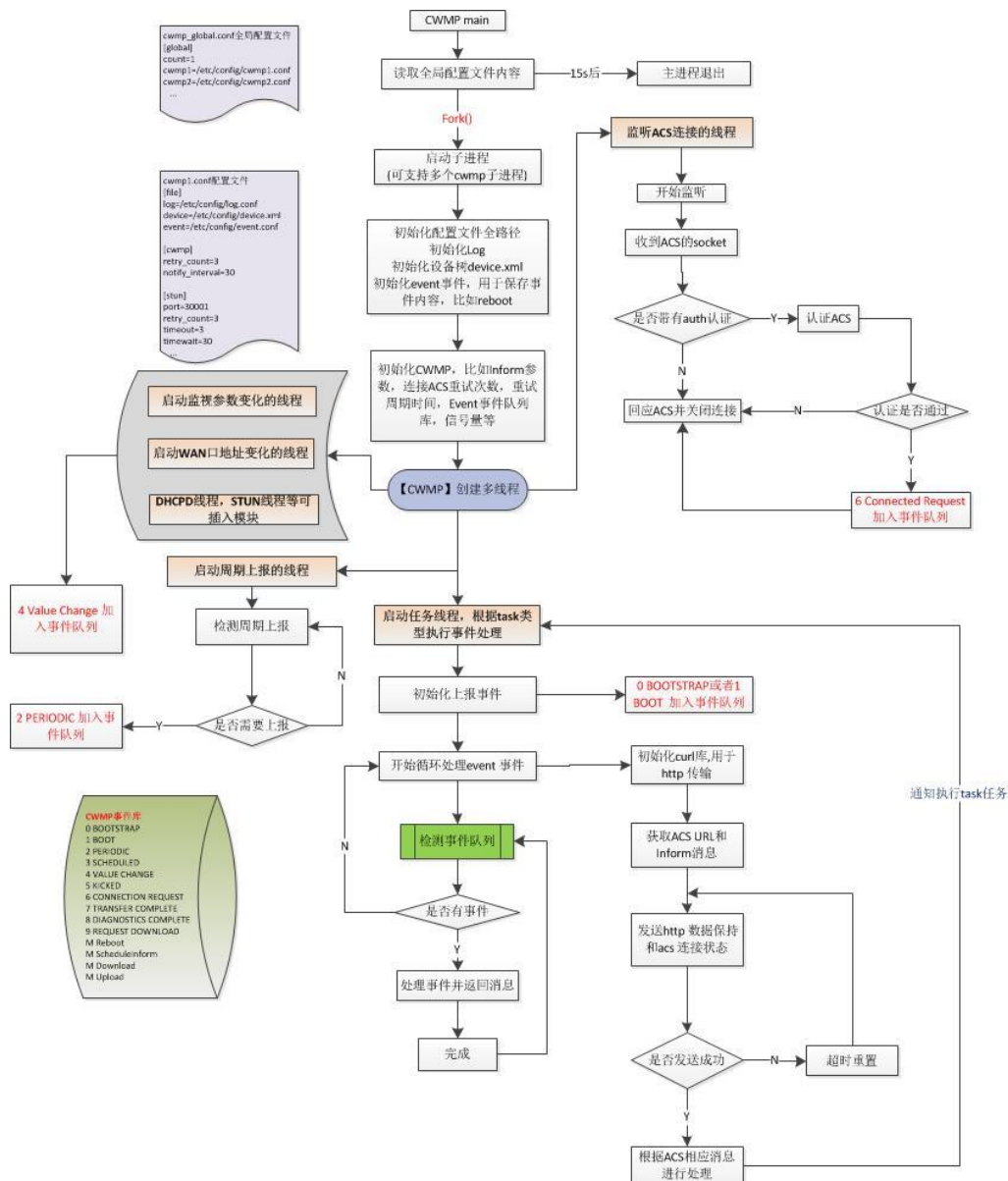

TR069 working flow chart of SIP-T790 phone:

- Open TR069 through web interface

1. Log in the phone interface via IP address.
2. Click **Setting(E)**->**TR069(I)**.
3. Enable TR069,input: user name, password, server IP address.
4. Enable periodic inform, periodic inform interval, username, password.
5. When finished please press **Confirm** to save.

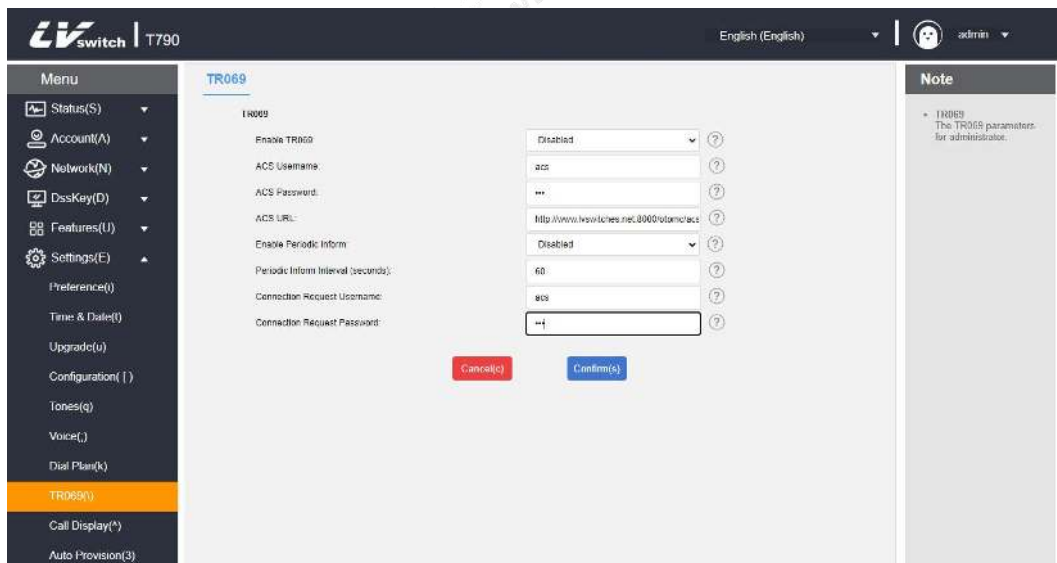

6.6 Configuration management

The SIP-T790 phone has a configuration management function. You can export the phone configuration through the configuration management, or you can modify the exported configuration and re-import the phone.

- BIN configuration

1. Log in the web interface via Ip address.
2. Click **settings(E)**->**Configuration(I)**->**BIN configuration** .
3. Import and export configuration, browse to select import configuration (you can also export configuration directly).
4. Click the import button.

- CFG configuration

1. Log in the web interface via Ip address.
2. Click **settings(E)**->**Configuration(I)**->**CFG configuration** .
3. Export CFG configuration files: network configuration, SIP configuration.
4. After selecting ,press **Export** button.
5. Import CFG configuration file: Import the modified configuration file
6. Press **Import** key.

Note The exported BIN CFG file can not be modified.
The exported CFG file can be modified.

6.7 Auto Provision

Automatic provision can deploy the same configuration to multiple phones on a large scale.

6.7.1 Preparing steps

- Prepare the necessary document:

Before performing automatic configuration, you need to perform the following steps:

- Get Boot boot file
- Obtain CFG configuration file
- Get phone related information
- Layout update environment

For **boot files** and **configuration files**, you can contact your dealer to obtain template files;

- The checking way of the related information of phones:

MAC: Press the **OK** button to view the phone in standby mode

Phone model: In standby mode, press **Ok ->More -> Device**, product name is the product model.

- Boot file description:

When the phone is automatically configured, it will first try to download the common.boot boot file, and guide the phone based on the boot file to reference the specified CFG configuration file. The specific sequence is as follows:

```

1 #!version:1.0.0.1
2 ## The header above must appear as-is in the first line
3
4
5 ##[${MODEL}]include:config <xxx.cfg>
6 ##[${MODEL},${MODEL}]include:config "xxx.cfg"
7
8 [SIP_T780]include:config<common_T780.cfg> Phone model: SIPT780. Corresponding configuration file is common_T780.cfg.
9 include:config <common.cfg> If not define the model. You can use common.cfg as the configuration file.
10 ##include:config "common.cfg"
11
12 overwrite_mode = 1
13 specific_model.excluded_mode=0
14

```

- Configuration file description:

Before configuring the phone, you need to obtain the CFG configuration file, common.cfg is the common configuration file, and mac.cfg is the mac-based configuration file; you can also create your own configuration files according to your needs, such as account.cfg for configuration of phone account number, etc. The configuration supports list as below:

The configuration of the phone:

Account, heartbeat service, DTMF, User Agent, time, STUN, network, Vlan, LLDP,

CDP, language, signal tone, QoS, sound

Features configuration:

Call forwarding, anonymous call, intercom, TR069, Programmable keys, DND, Hotline, voicemail, keypad lock, Action URL, Auto update

Other configurations:

Upgrade phone and pager configuration

Example: If the phone needs to be upgraded to a specified version, and the language is set to Chinese, create a LanguageAndUp.cfg file, add the configuration and place it in the server root directory.

```
### language ###
```

```
language_setting.languages = 0
```

```
### upgrade ###
```

```
static.firmware.url = ftp://192.168.17.xx/V2.0.0.3_T790_rootfs.sqhfs
```

Note If you set up an upgrade, the upgrade file must be in this directory, otherwise the upgrade will fail.

6.7.2 Automatic update operation steps:

There are two methods of server.

- HTTPS
- FTP/TFTP

6.7.2.1 HTTP(S) method update

To configure the server, just run HFS.exe directly; after running, put the configuration file directly under the environment root directory; the configuration file includes files such as xx.boot and xx.cfg.

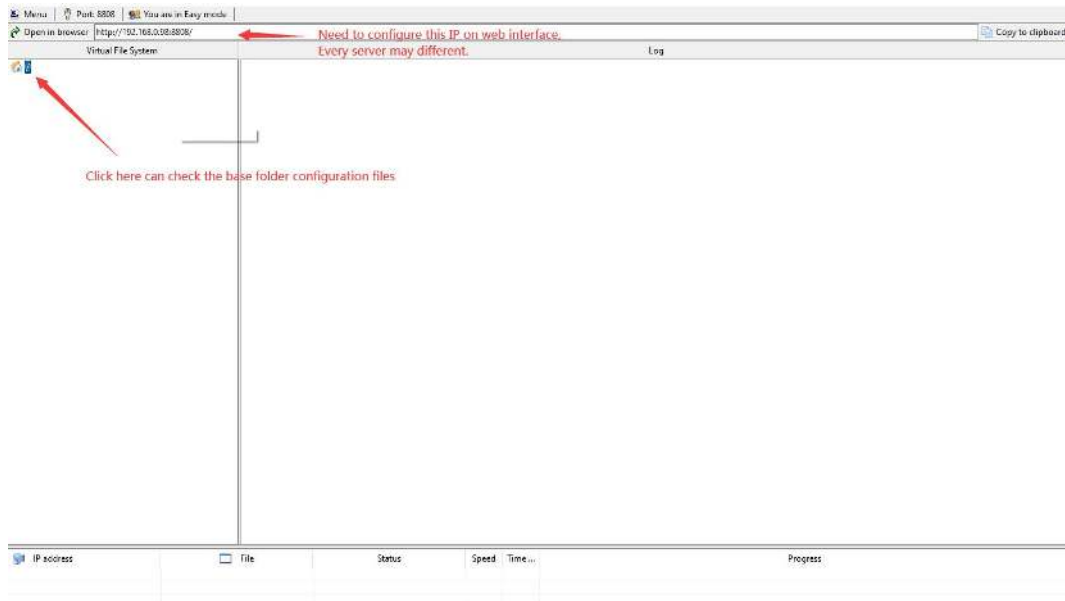

Root directory file map:

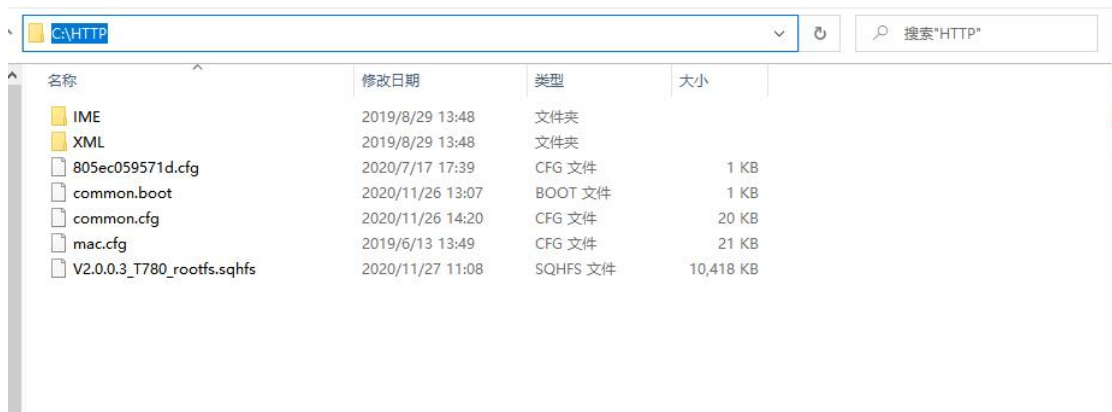

Setting steps:

1. Login Web interface.
2. Click **Settings(E) ->Auto provision(3)**
3. server URL Fill in the https address
such as http(s)://192.168.17.xx, enable power on and start. Automatic configuration information update after restart.

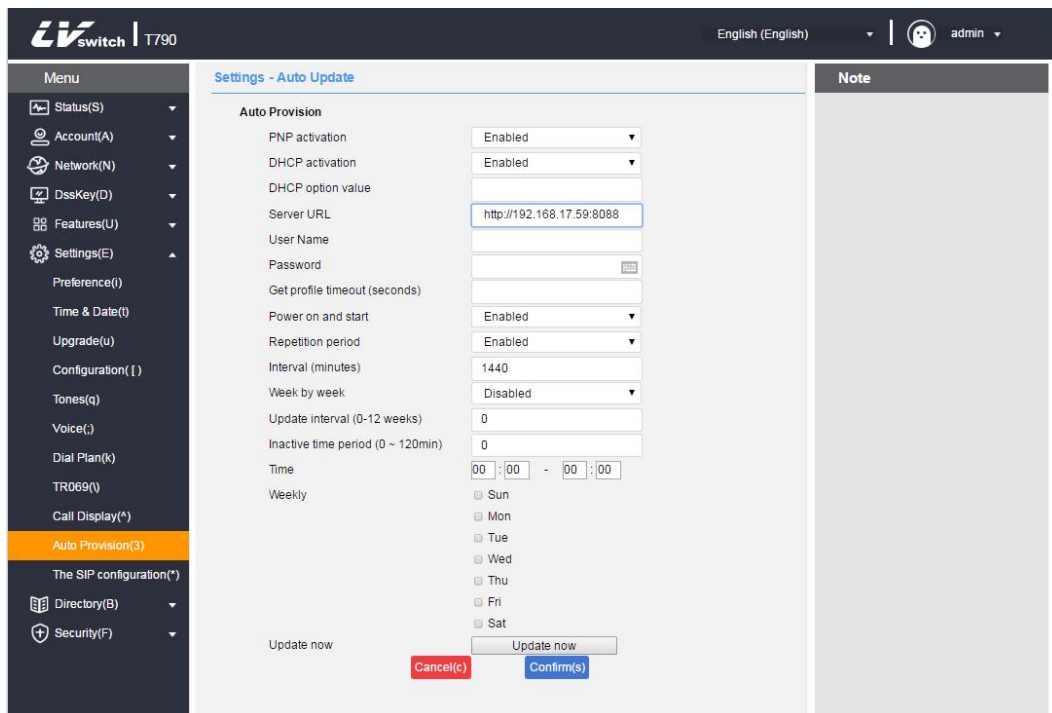

6.7.2.2 FTP/TFTP method update:

To configure the server, run IPOP.exe directly to enable FTP/TFTP in the service, or you can use 3C Daemon, TFTP32, etc. as the server; after running, put the configuration file directly in the environment root directory; the configuration file includes xx.boot and xx.cfg, etc. File. The configuration steps are as follows:

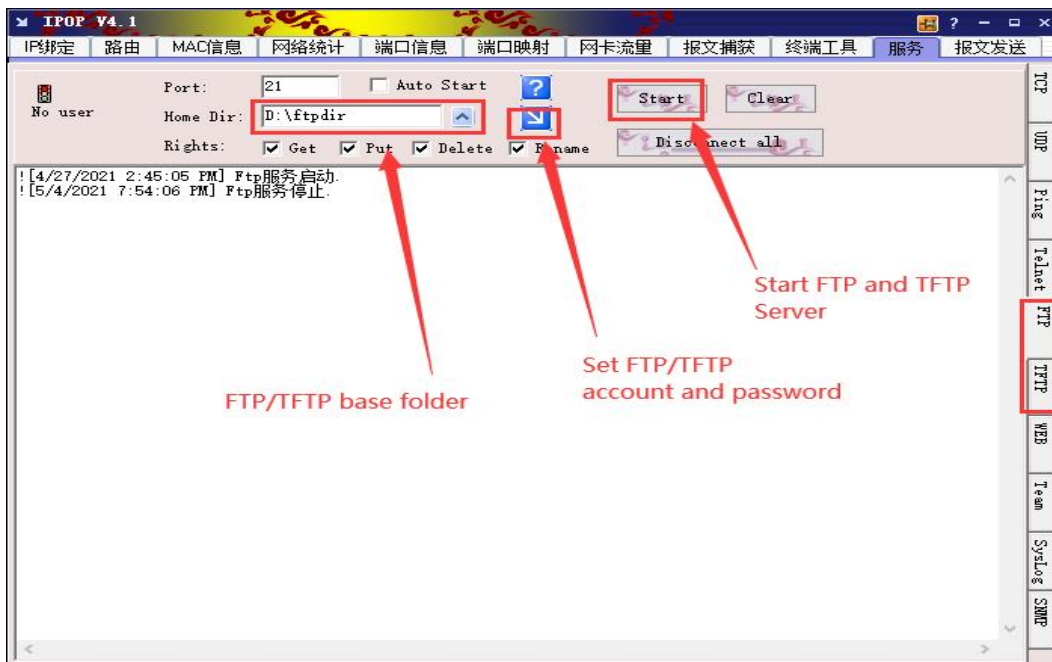

Setup steps:

1. Login Web interface.
2. Click **Settings(E)** -> **Auto provision(3)**
3. server URL fill in the ftp/tftp address, for example: <ftp://192.168.17.xx/> Enable power-on startup; automatic configuration information update after restart.

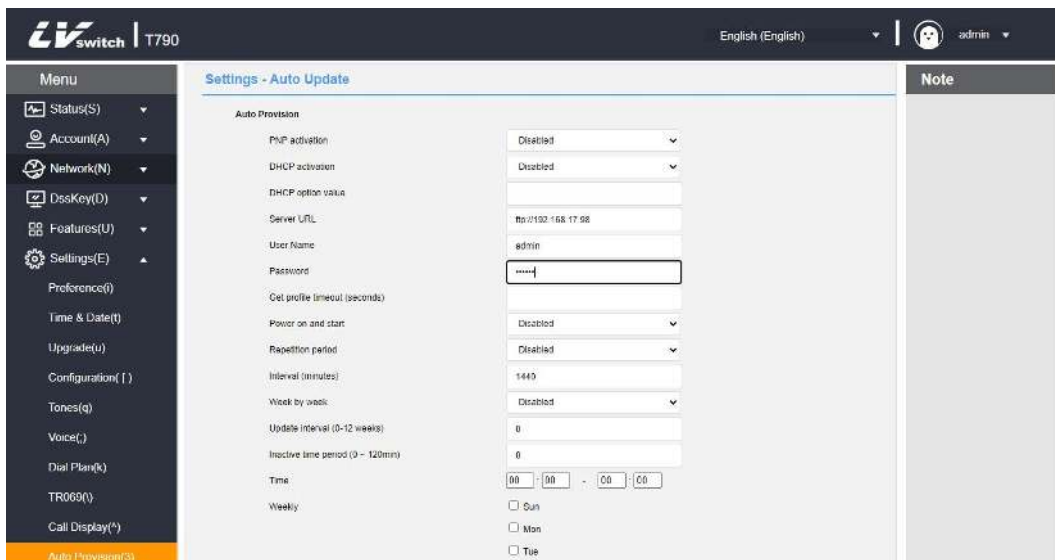

6.8 SIP configuration

6.8.1 SIP Session Timer

SIP session timers T1, T2, and T4 are SIP transaction layer timers defined in RFC 3261.

- Configure SIP session timer through web page

(Only through web page configuration)

1. Login Web interface.
2. Click **Settings(E)**-> **The SIP configuration (*)**.
3. Check SIP Session Timer T1/T2/T4.
4. Press **Confirm** button to save.

SIP session timer T1: Timer T1 is an estimate of the round trip time (RTT) of the transaction between the SIP client and the SIP server.

SIP session timer T2: Indicates the maximum retransmission time of any SIP request message. The retransmission multiplication of T1 will continue until the retransmission time reaches the value of T2.

For example: the user registers a SIP account and sets the values of timer T1 and timer T2 respectively (timer T1:0.5, timer T2:4). The SIP registration request message will be retransmitted between the phone and the SIP server. The retransmission multiplication of timer T1(0.5) will continue until the retransmission time reaches timer T2(4). The total registration request retry time will be less than 64 times of T1 ($64 * 0.5 = 32$). The retransmission interval is: 0.5s, 1s, 2s, 4s, 4s, 4s, 4s, 4s, 4s, 4s, 4s, 4s, 4s, 4s, 4s, 4s.

SIP session timer T4: Indicates the time for the network to clear messages between the SIP client and server.

power save mode	
SIP Session Timer T1 (0.5-10 SEC)	0.5
SIP Session Timer T2 (2-40 SEC)	4
SIP Session Timer T4 (2.5-60 SEC)	5
Local SIP Port	5090
The TLS SIP port	5091

Cancel(O)
Confirm(S)

6.8.2 Local SIP port and TLS SIP port

If NAT is not enabled, the port number is displayed in the header of Via and Contact in the SIP message. If NAT is enabled, the phone will use the NAT port and address in the header fields of via and contact, but will still use the configured source port.

- Configure local SIP port and TLS SIP port via web page

1. Login Web interface.
2. Click Settings(E)-> The SIP configuration (*).
3. Check Local SIP port and TLS SIP port.

4. Press **Confirm** button to save.

6.9 Action URL

The Action URL function is mainly used for the phone to report its own behavior to the computer. An action on the phone generates a URL. The actions on the phone include incoming calls, outgoing calls, and call forwarding. The web management interface lists all supported actions, and each action corresponds to a URL that can be customized by the user. When a certain action occurs, such as an incoming call, the phone and the corresponding URL HTTP/HTTPS GET is sent to the computer, so as to achieve the purpose of reporting its own action.

URL format: `http(s)://server address/help.xml?mac=$mac`

6.9.1 The action that can realize reporting to the server

The action that can realize reporting to the server and the list of variables supported by each action.

The actions that can be reported	Description	Supported variables
Startup complete	When IP phone startup completely.	\$mac \$ip \$model \$firmware(Base)
Registered	When SIP account registered.	\$mac \$ip \$model \$firmware

		\$local
unregister	When SIP account unregister.	Same as above
Register failure	When SIP account register failure.	Same as above
Put down the handle	When the handset hangs up.	\$mac \$ip \$model \$firmware(Basic)
Pickup the handle	When the handle is off-hook	Same as above
Incoming call	When ip phone has incoming call	\$mac \$ip \$model \$firmware \$active_url \$active_user \$active_host \$local \$remote \$display_local \$display_remote \$call_id \$callerID \$calledNumber(Call related)
Dial a call	When ip phone dial a call	Same as above
Establish a session	When the session is establishing	Same as above
End a session	When the session is finish.	\$mac \$ip \$model \$firmware
Enable DND	Enable 'do not disturb'.	Same as above
Disable DND	Disable 'do not disturb'.	Same as above
Enable call forwarding unconditionally	Enable call forwarding unconditionally.	Same as above
Disable call forwarding unconditionally	Disable call forwarding unconditionally.	Same as above
Enable call forwarding on busy	Enable call forwarding on busy.	Same as above
Disable call forwarding on busy	Disable call forwarding on busy.	Same as above
Enable call forwarding on no	Enable call forwarding on no answers.	Same as above

answers		
Disable call forwarding on no answers	Disable call forwarding on no answers.	Same as above
Call forward	When a call transfer occurs.	\$mac \$ip \$model \$firmware \$active_url \$active_user \$active_host \$local \$remote \$display_local \$display_remote \$call_id \$callerID \$calledNumber
Blind transfer	When the blind transfer occurs.	Same as above
Inquiry transfer	When the inquiry transfer occurs.	Same as above
Call hold	Hold the call.	Same as above
Cancel call hold	Un-hold the call.	Same as above
Enable mute	Enable mute.	Same as above
Disable mute	Disable mute.	Same as above
Unanswered calls	When you get unanswered calls.	Same as above
IP change	When the ip phone IP address changes.	Same as above
Idle into a call	When the phone enters the call state from the idle state.	\$mac \$ip \$model \$firmware \$active_url \$active_user \$active_host \$local \$remote \$display_local \$display_remote \$call_id \$callerID \$calledNumber
The call enters into idle	When the phone enters the idle state from the call state.	Same as above
Reject incoming calls	When you reject the incoming calls.	Same as above
Answer new incoming calls	When you answer a new incoming call.	Same as above

Forward failure	When the call forward failure.	Same as above
Forward complete	When the call forward is complete.	Same as above
Forward call	When forwarding a incoming call.	Same as above
Update automatically	When the automatic update is complete.	Same as above
Enable call waiting	Enable call waiting.	\$mac \$ip \$model \$firmware
Disable call waiting	Disable call waiting.	Same as above
Use headset	When using the headset.	Same as above
Use hands-free	When using speaker.	Same as above
Cancel callout	When you cancel dial out call.	Same as above
Remote busy	The remote call is busy.	Same as above
Cancel remote call	When the remote call cancel.	Same as above
Peripheral information	When peripheral information is update.	Same as above
VPN IP	When the VPN IP address was changed	Same as above

6.9.2 Variable description

Variables supported in Action URL.

The actions that can be reported	Description
\$mac	Phone MAC address
\$ip	Phone IP address
\$model	Phone type
\$firmware	The phone's firmware version number
\$active_url	The sip_uri of the current active account (only valid for incoming, outgoing, and calling)
\$active_user	Reissue the user account of the sip_uri of the current active account (only valid for incoming, outgoing, and calling)
\$active_host	The server part of the sip_uri of the current active account (only valid for incoming, outgoing, and calling)
\$local	Native sip_uri
\$remote	The peer sip_uri
\$display_local	Native display name
\$display_remote	The peer display name
\$call_id	Caller ID
\$callerID	The display name of the caller when making an outgoing call
\$calledNumber	The number called when calling out

6.9.3 Web page configuration description

- Configuration Action URL via web interface:

1. Login Web interface.
2. Click **Features(U)**->**ActionURL(6)**.
3. Enter the information to be reported to the server in the corresponding area.

For example:

http(s)://server address/help.xml?mac=\$mac

4. Click **Confirm** button to save.

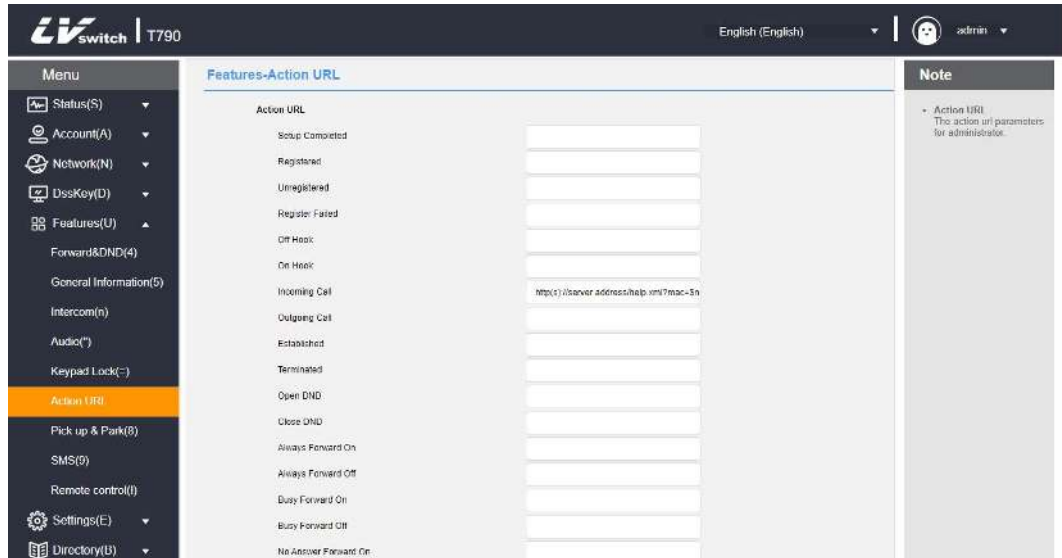

6.10 Trusted Certificates

You can upload a specific CA certificate to your phone.

- Configure trusted certificates via web interface

1. Login Web interface.
2. Click **security(F)**-> **Trusted Certificates(@)**.
3. Select the appropriate value from Only trusted certificates are allowed/User name confirmation/CA certificate.
4. Click **Confirm** to confirm the operation.

A dialog box pops up, prompting to take effect after restart.

5. Click **OK** to restart the phone.

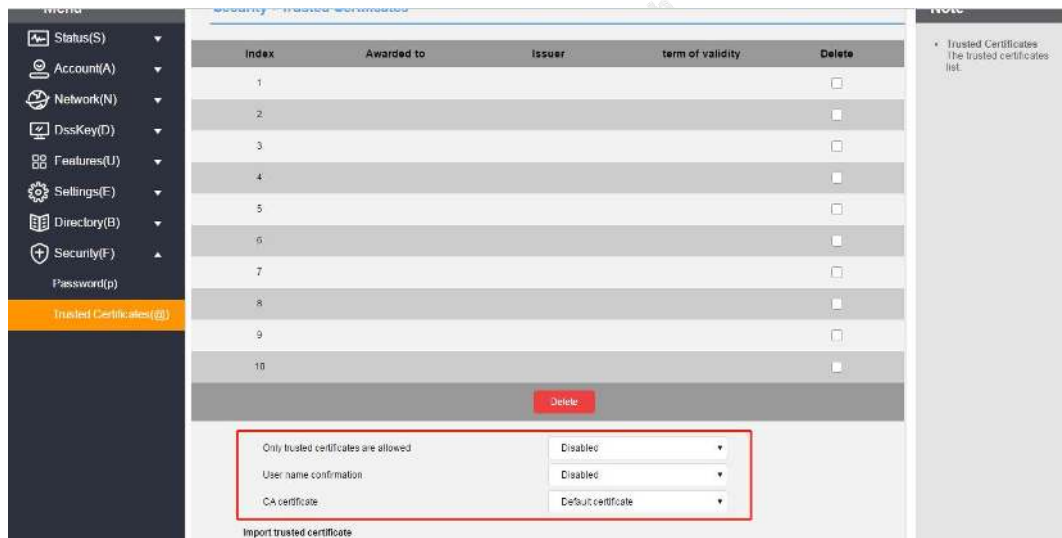

- Upload trusted certificate via web page

1. Login Web interface.
2. Click **security(F)**-> **Trusted Certificates(@)**.
3. In the Load Trusted Certificate File area, click Browse to select the local certificate file (*.pem, *.crt, *.cer 或 *.der)
4. Click import to import the certificate.

